

Uniden®

UBCD3600XLT Owner's Manual



Printed in Vietnam
U01UB376BZZ(0)

IMPORTANT NOTE ABOUT THIS MANUAL



NOTE

Radio Reference database for use in North America ONLY.

The AMBE+2™ voice coding Technology embodied in this product is protected by intellectual property rights including patent rights, copyrights and trade secrets of Digital Voice Systems, Inc.

microSD is a registered trademark of SanDisk Corporation.

HomePatrol is a registered trademark of Uniden America Corporation, Irving, Texas.

CONTENTS

IMPORTANT INFORMATION.....	1
MODIFICATION NOTICE	1
GENERAL PRECAUTIONS.....	1
Earphone Warning	1
Liquid Exposure Warning	1
Power Disconnection Caution	1
INTRODUCTION.....	2
CREATE FAVORITES LISTS	2
AVOID TRANSMISSIONS	2
REPLAY TRANSMISSIONS	2
RECORD TRANSMISSIONS	2
MAIN FEATURES	2
INCLUDED WITH YOUR SCANNER	5
USING INTERNAL BATTERIES	6
Using Rechargeable Batteries	6
UNDERSTANDING THE MEMORY	6
FAVORITES LISTS	6
SYSTEMS	7
TRUNKING SITES.....	7
DEPARTMENTS	7
SENTINEL SOFTWARE	7
MANAGE PROFILES	7
MANAGE FAVORITES LISTS	7
HOW TO INSTALL SENTINEL SOFTWARE	7
UPDATING FIRMWARE	7
SETTING UP YOUR SCANNER.....	9
TURN ON THE SCANNER	9
KEYPAD CONTROLS	10
SET YOUR LOCATION AND RANGE.....	13
SET LOCATION.....	13
SET RANGE	13
UNDERSTANDING RANGE	13
EDIT LOCATION	13
SELECTING SERVICE TYPES	14
NAVIGATING THE MENUS.....	15
DATA NAMING.....	15
DISPLAY MENU	15
A Look at the Display	16
SETTINGS MENU	20
Adjust Key Beep	20

Battery Option	20
Band Defaults	20
Auto Shutoff	20
Set Clock	20
Replay Options	21
Restore Options	21
See Scanner Information.....	21
Keypad Lock	21
KEY CONCEPTS.....	22
QUICK KEYS	22
FAVORITES LIST QUICK KEYS.....	22
SYSTEM QUICK KEYS.....	22
DEPARTMENT QUICK KEYS.....	22
SEARCH KEYS.....	22
PLANNING PROFILES.....	22
STARTUP KEYS	22
NUMBER TAGS	23
ALERTS	23
MANAGING FAVORITES LISTS	23
NEW FAVORITES LIST/ FAVORITES LIST OPTIONS	23
MANAGING FAVORITES LISTS.....	24
UNDERSTANDING LOCATION CONTROL	24
PROGRAMMING SYSTEMS.....	25
NEW SYSTEM/SYSTEM SETTINGS	25
SYSTEM SETTINGS.....	25
SYSTEM OPTIONS	26
PROGRAMMING SITES.....	28
NEW SITE/SITE OPTIONS.....	28
PROGRAMMING DEPARTMENTS	31
NEW DEPARTMENT/DEPARTMENT OPTIONS	31
DEPARTMENT OPTIONS	31
PROGRAMMING FREQUENCIES/TGIDS	33
QUICKLY STORING A FREQUENCY/TGID.....	33
NEW CHANNEL/CHANNEL OPTIONS	33
CHANNEL OPTIONS	34
SET SCAN SELECTION	36
USING STARTUP KEYS	36
TO USE A STARTUP KEY:	36
PRIORITY SCANNING.....	37
PRIORITY SCAN OPTIONS.....	37
SCANNING BY ASSIGNING QUICK KEYS	38
SELECTING QUICK KEYS	40

TOGGLE DISPLAY MODES.....	41
TOGGLE ID SCAN OR ID SEARCH	41
SELECT SERVICE TYPES	41
HOLDING.....	41
REPLAY THE LAST TRANSMISSIONS	41
START/STOP RECORDING	41
ADVANCED CHANNEL MENU	41
STORE A SEARCH FREQUENCY (SEARCH WITH SCAN)	42
ATTENUATION.....	42
MODULATION	42
Conventional Channel Modulation	42
Site Modulation	42
INTERMEDIATE FREQUENCY EXCHANGE	42
REPEATER FREQUENCY CONVENTIONAL CHANNEL	42
CHANNEL VOLUME OFFSET.....	43
AVOIDING CHANNELS, DEPARTMENTS, SITES, AND SYSTEMS.....	43
SET THE RANGE	43
DIRECT FREQUENCY/TGID ENTRY.....	43
USING NUMBER TAGS	43
CLOSE CALL MODES.....	44
Close Call Hit	44
PRIORITY MODES	45
Weather Alert Priority	45
CUSTOM SEARCH BY SEARCH KEY	45
CLOSE CALL ONLY	45
TONE-OUT STANDBY/SEARCH	45
REVIEW AVOIDS	45
QUICK SEARCH	45
DIGITAL ADJUSTMENT MODE.....	46
USING A GPS.....	46
LOCATION-BASED SCANNING	46
DISCOVERY MODE	47
NEW SESSION.....	47
SESSION OPTIONS.....	48
Start Discovery	48
Edit Session Name	48
Set Limit Frequencies (Conventional Only).....	48
Set Modulation (Conventional Only).....	48
Set Step (Conventional Only).....	48
Set Delay.....	48
Set Logging	48
Set Compare to Database.....	49

Set Record Duration	49
Set Time-Out Timer	49
System Information (Trunking Only).....	49
Set Auto Store	49
Delete Session	49
Change System (Trunking Only).....	49
REVIEW DISCOVERY	49
SEARCH/CLOSE CALL OPTIONS	50
SEARCH OPTIONS	52
SET SEARCH KEY.....	53
SEARCH WITH SCAN	53
QUICK SEARCH	53
CUSTOM SEARCH.....	53
Change Direction or Resume Search	54
Select Custom Search Bands	54
Holding	54
Avoiding Frequencies.....	54
Attenuation	54
Modulation	54
Direct Frequency Entry	54
Frequency Intermediate Exchange	54
Repeater Frequency	54
Replay the Last Transmissions.....	54
Start/Stop Recording	55
Storing Frequencies	55
Search Menu	55
Close Call Modes	55
CLOSE CALL.....	55
CLOSE CALL OPTIONS	56
Close Call Only	56
Hits with Scan	56
Set CC Mode	56
Set CC Bands	56
Set CC Alert	57
Close Call Only Mode	57
Toggle Close Call Bands.....	57
Cancel a Hit	57
Holding on a Hit.....	57
View Last Hit	58
Avoiding Hits	58
Attenuation	58
Modulation	58

Intermediate Frequency Exchange	58
Repeater Frequency	58
Replay the Last Transmissions	58
Start/Stop Recording	59
Storing	59
Close Call Menu	59
FIRE TONE-OUT	60
TONE-OUT SETUP	60
Edit Name	60
Set Frequency	60
Set Tone	60
Set Delay Time	61
Set Alert	61
Set Audio AGC	61
FIRE TONE-OUT STANDBY/SEARCH	61
Select a Different Tone-Out	62
Listen to Tone-Out Frequency	62
APPENDIX	63
TROUBLESHOOTING	63
Scan Mode, Nothing to Scan	63
Scanning Interrupted	63
All Channels Out of Range	63
DEFAULT BAND COVERAGE	63
SERVICE TYPES	64
Reformatting the microSD Card	65
ENTERING IDS	65
TYPE II SPECIAL STATUS BITS	66
CTCSS FREQUENCIES	66
DCS CODES	68
REVERSE LIST	68
TECHNICAL SPECIFICATIONS	69
DECLARATION OF CONFORMITY	72



IMPORTANT INFORMATION

MODIFICATION NOTICE

Changes or modifications to this product not expressly approved by Uniden, or operation of this product in any way other than as detailed by this Users Guide, could void your authority to operate this product.

GENERAL PRECAUTIONS

Before you use this scanner, please read and observe the following:

Earphone Warning

You can use an optional 32Ω stereo headset or earphone with your scanner. Use of an incorrect earphone or headset might be potentially hazardous to your hearing. The output of the phone jack is monaural, but you will hear it in both headphones of a stereo headset.

Set the volume to a comfortable audio level coming from the speaker before plugging in the earphone or headset. Otherwise, you might experience some discomfort or possible hearing damage if the volume suddenly becomes too loud because of the volume control or squelch control setting. This might be particularly true of the type of earphone that is placed in the ear canal.

Liquid Exposure Warning

Uniden does not represent this unit to be waterproof. To reduce the risk of fire or electrical shock, do not expose this unit to rain or moisture!

Power Disconnection Caution

IMPORTANT: Always turn the scanner off before disconnecting external power. Some settings are saved only as the scanner is powering down.

INTRODUCTION

The Uniden UBCD3600XLT is digital TrunkTracker V communications receivers that require no user programming. Simply turn it on, enter your location, and you will immediately begin hearing communications in your area. This functionality is made possible by combining the rich radio system database from RadioReference.com with Uniden's patented radio system selection methods to correctly identify and monitor only nearby systems.



All Radio Reference database options are for use in North America ONLY.

CREATE FAVORITES LISTS

As you find transmissions you like and would like to monitor again, you can save them to a Favorites List. When you opt to listen to a Favorites List, your scanner will monitor only the transmissions from that list.

You can assign a Quick Key to a Favorites List (FLQK) that allows you to quickly turn a Favorites List on or off by simply entering the quick key on the keypad while scanning.

AVOID TRANSMISSIONS

You can also select transmissions for your scanner to Avoid (ignore).

REPLAY TRANSMISSIONS

Your scanner Replay feature acts as an instant replay of the transmissions you've just heard. You can set how long a period Replay records for instant playback. This period can range from 30 seconds to 240 seconds (4 minutes). While you can replay that recording immediately and continue replaying it, you cannot save it for future listening.

RECORD TRANSMISSIONS

With your scanner, you can record transmissions. When you begin recording, your scanner adds the Replay recording buffer to the recording. These recording sessions are saved and can be replayed on demand. Rename and delete sessions through the Review Recordings submenu.

MAIN FEATURES

Favorites Scan – Allows you to organize your Systems into Favorites Lists. The scanner will scan multiple Favorites Lists and Full Database at the same time.

4 GB microSD card (provided - 1 GB up to 32 GB supported) – For storing Favorites Lists, Profiles, all your settings, Discovery sessions, and recording sessions.

Location Based Scanning – Connect to a GPS receiver (not included) for precise system selection and continuing reselection when you travel. The scanner can automatically Avoid and Unavoid Systems and Departments based on your current location as provided by an external GPS unit.

Range Control – Lets you set how far out from your current location the scanner will search for channels in Favorites Lists. Location precision for departments and sites that allows you to define a location and range using rectangles instead just of a single circle.

Trunk Tracker V Operation – Scans APCO 25 Phase 1 and Phase 2, DMR, Motorola, EDACS, EDACS ProVoice, and LTR trunked systems, as well as conventional analog and P25 digital channels.

Multi-Site Trunking – Lets you program the scanner to share trunked system IDs across multiple sites without duplicating IDs.

Control Channel Only Scanning – With Motorola trunking frequencies, you do not have to program voice channel frequencies.

Instant Replay – Plays back up to 240 seconds (4 minutes) of the most recent transmissions.

Audio Recording – Capture transmissions for later playback.

Custom Alerts – You can program your scanner to alert when you receive, a Channel or Unit ID, a Close Call hit, an ID is transmitted with an Emergency Alert, or a Tone-out hit. For each alert in the scanner, you can select from 9 different tone patterns, 15 volume settings, 7 colors, and 2 flash patterns.

Multicolor LED Alert – The alert LED with 7 colors, Blue, Red, Magenta, Green, Cyan, Yellow, or White, can be used with your Custom Alerts.

Trunking Discovery – Monitors system traffic on a trunked radio system to find unknown IDs and automatically records audio from and logs new channels for later review and identification.

Conventional Discovery – Searches a range of frequencies to find unknown frequencies and automatically records audio from and logs new channels for later review and identification.

Scan by Service Types – Scan your channels by Service Type i.e. Fire, Police, Railroad, etc.

Search Speed – 80 step/sec. (typical) in Search mode (max) except for 5 kHz steps. 250 step/sec. (typical) in Search mode (max) – (Turbo Search) for 5 kHz steps.

Multi-Level Display and Keypad light – Makes the display and keypad easy to see in dim light with three light levels.

Temporary or Permanent Avoid – For Systems/Sites/Departments/Channels.

System/Channel Number Tagging – Number tags allow you to quickly navigate to a specific Favorites List, System, or Channel.

Start-up Configuration – You can program each of your Favorites Lists with a Startup Key (0-9) so that when you power up the scanner and press the key number, just those Favorites Lists assigned to the key will be enabled for scan.

Close Call® RF Capture Technology – Lets you set the scanner so it detects and provides information about nearby radio transmissions. Close Call Do-not-Disturb checks for Close Call activity in between channel reception so active channels are not interrupted.

Broadcast Screen – Allows the scanner to ignore hits in search and Close Call modes. You can also program up to 10 custom frequency ranges that the scanner will ignore.

Fire Tone-Out Standby/Tone Search – Lets you set the scanner to alert you if a two-tone sequential page is transmitted. You can set up to 32 Tone-Outs. The scanner will also search and display unknown tones.

PC Programming – Use the Sentinel software to manage your scanners Profiles, Favorites Lists, and firmware updates.

Analog and Digital AGC – Helps automatically balance the volume level between different radio systems.

Priority/Priority w/DND Scan – priority channels let you keep track of activity on your most important channels while monitoring other channels for transmissions.

Priority ID Scan – Allows you to set priority to talkgroup IDs.

Intermediate Frequency Exchange – Changes the IF used for a selected channel/frequency to help avoid image and other mixer-product interference on a frequency.

Individual Channel Volume Offset – Allows you to adjust the volume offset for each channel.

Configurable Band Defaults – Allows you to set the step (5, 6.25, 7.5, 8.33, 10, 12.5, 15, 20, 25, 50 or 100 kHz) and modulation (AM, FM, NFM, WFM, or FMB) for 31 different bands.

Adjustable Scan/Search Delay/Resume – Set a delay up to 30 seconds or a forced resume up to 10 seconds for each channel or search.

Data Naming – Allows you to name each Favorites List, System, Site, Department, Channel, ID, Location and Custom Search, using up to 64 characters.

Duplicate Input Alert – Alerts you if you try to enter a duplicate name or frequency already stored in the scanner.

100 Quick Keys – You can scan Favorites Lists, Systems, and Departments by assigning them to quick keys.

Search Avoids – You can temporarily Avoid up to 250 frequencies and permanently Avoid up to 250 frequencies in any Search mode or Close Call mode.

10 Custom Searches – Lets you program up to 10 custom search ranges.

Search with Scan Operation – Lets you include Custom Search ranges during scan operation.

3 Search Keys – You can assign 3 of the number keys to start a Custom Search, Tone-Out Search, or Close Call Search.

Quick Search – Lets you enter a frequency and start searching.

Built-in Battery Charger – Allows you to charge the batteries in the scanner.

INCLUDED WITH YOUR SCANNER

Accessories included in the box are:

USB Connection Cable
3 X AA NiMH Rechargeable Batteries
microSD card (installed)
Swivel Belt Clip (attached)
SMA-BNC Antenna Adaptor
Rubber Antenna
AC Adaptor



USING INTERNAL BATTERIES

You can power your scanner using three alkaline or rechargeable AA batteries.

There is no switch for the battery type. Using non-rechargeable batteries, select “No” at the Battery message when connecting the USB cable.

1. Install 3 AA batteries, matching the polarity symbols (+ -).
2. Replace the cover.

When Battery icon flashes and the scanner beeps every 15 seconds, replace or recharge the batteries.

Using Rechargeable Batteries

You can also use three rechargeable batteries to power your scanner. Before you use rechargeable batteries, you must charge them. The scanner has a built-in circuit that lets you recharge batteries while they are in the scanner.

If the USB cable is connected to the scanner, or batteries are installed in the scanner when an USB cable is connected, the scanner will check the battery condition.

When the scanner is turned on, the scanner does not charge the batteries.

When the scanner is turned off, the scanner will charge the batteries.

The scanner displays “Normal Charging” while charging the batteries according to the Set Charge Time setting.

Caution: If the scanner gets too hot while charging, it will turn off automatically.

If the batteries are not installed, “No Battery” is displayed.

UNDERSTANDING THE MEMORY

All of the information contained in the scanner is stored on a microSD card supplied with the scanner. This includes Favorites Lists and all the radio settings.

FAVORITES LISTS

Because the memory is based on the Radio Reference database we now have a different order of organization not like banks and channels in traditional scanners, but more like Dynamic Memory Architecture. You can now use Favorites Lists that follow RR database structure of Systems that contain Departments that hold the Channels (conventional frequencies or IDs) and then there are Sites to hold just the trunking frequencies. If you are familiar with DMA (Dynamic Memory Architecture) scanners, think of departments as being like channel groups.

Favorites Lists will allow you to store channels you find when you are scanning from the full database (the easiest way). They can contain channels from trunking systems and conventional systems. You can also manually add systems, (not single sites), departments and channels into Favorites Lists from the database as well as program new systems, departments, sites, and channels with the Sentinel software.

You can save up to 256 different lists in the scanner (and software) and associate them with any or all of your profiles. You can monitor one or more lists at a time and/or the database. You can also export you lists to a file to share them. Deleting a profile will not delete the lists associated with a profile. However, deleting a Favorites List will delete it from all profiles.

SYSTEMS

Systems will hold all of your Sites, Departments, and Channels.

TRUNKING SITES

Inside systems are trunked sites hold the trunking frequencies for any trunking system and any band plan information needed. You will need at least one site for each trunked system and some systems can have several sites.

DEPARTMENTS

Departments are also created inside systems. Departments hold frequencies (channels) for conventional systems and IDs (also called channels) for trunked systems.

SENTINEL SOFTWARE

MANAGE PROFILES

Profiles are “snapshots” of your scanner’s set up. A profile contains all your configuration settings as well as all of your Favorites Lists, Avoids, and System settings. Sentinel can save multiple profiles so you can also restore different profiles as you need them. For example, If you regularly visit a specific location, you can create a profile for that location. You can save it to Sentinel to use whenever you visit.

MANAGE FAVORITES LISTS

You can create Favorites Lists in Sentinel and then associate them with specific profiles. Sentinel allows you to create your own systems, or edit systems already in a Favorites Lists. When those profiles are written to your scanner, only specified Favorites Lists are written to the scanner.

HOW TO INSTALL SENTINEL SOFTWARE

If you have not already installed Sentinel software, follow these procedures.

1. Use the USB cable to connect your scanner to your PC.
2. Turn on the scanner if it is not already on. Select *Mass Storage*.
3. *USB Mass Storage* displays while it is connected to the PC.
4. The microSD card in your scanner will install to your PC like an additional drive.
5. Open the drive folder and Double-click *setup.exe* in the Setup folder.
6. When installation is complete, Sentinel software is installed on your PC.
7. You can now disconnect the USB cable.
8. Sentinel will automatically notify you if a more recent version is available.

UPDATING FIRMWARE

Your scanner updates its firmware through Sentinel. In that process, Sentinel connects to the internet and checks for the current firmware version to download.

From time to time, Uniden will release firmware updates to improve existing functionality, add new features, or address issues found in its operation. Updating the firmware takes just a few minutes and is easily accomplished using the Sentinel Software you installed on your PC.



Simply connect your scanner to your PC using the supplied USB cable and select *Mass Storage*. Then, in Sentinel select *UPDATE/Update Firmware* and follow the on-screen prompts.

SETTING UP YOUR SCANNER

TURN ON THE SCANNER



Procedure

1. Press and hold  for about 2 seconds.
2. If the screen is too dark, tap  to turn on the backlight.
3. Press the scroll control to display the volume level. Turn the scroll control (within 10 seconds) to adjust the volume.
4. Press the scroll control again to close the volume level (or let it disappear after 10 seconds).
5. Press **Func** then press the scroll control to display the squelch level. Turn the scroll control counter-clockwise all the way then clockwise until the noise stops, then one notch more.
6. Press the scroll control again to close the squelch level.

THE FIRST TIME YOU TURN ON YOUR SCANNER IT WILL PROMPT YOU TO SET THE CLOCK. SEE SETTING THE CLOCK.

KEYPAD CONTROLS



Key	Operation
Power/Light/Lock 	<ul style="list-style-type: none"> Press and hold to turn the scanner on or off. Press to use the backlight. Press Func then to lock or unlock the keypad.
Func (Function)	Press to enter Function mode for 3 seconds.
Scroll Control (Select, Volume, Squelch)	<ul style="list-style-type: none"> Press then turn the Scroll Control knob to adjust volume level in Scan mode. Press Func then turn the Scroll Control knob to adjust the squelch. Press the Scroll Control knob, then Func, then the Scroll Control knob again to view P25 Adjustment mode. Press to select a menu item or save an entry in Menu mode. Turn to select characters with Data Naming. Turn to select Scan/Search direction and to continue Scan/Search in Scan/Search modes. Turn to scroll Channel or Frequency in Hold mode. Turn in Department Pause to scroll Departments. Turn in System Pause to scroll Systems. Turn in Site Pause to scroll Site in current system. Turn in Search Pause to select Custom Search Banks to enable in Search mode. Turn to select next or previous recording in Replay mode. Turn to resume Close Call search in Close Call mode. Turn to start a Quick Search Hold mode in Close Call Hold mode. Turn to select Tone-Outs in Tone-Out Standby mode.

Key	Operation
Avoid 	<ul style="list-style-type: none"> • Press to return to previous mode in Menu mode. • Press to toggle Channel/Frequency Avoid status in Receive/Hold modes. • Press to toggle Avoid status in System, Department, or Site Pause. • Press and hold to clear all System/Site/Department/Channel Avoids in current systems in Scan Hold mode. • Press and hold to clear Search Avoids in Search Hold mode. • Press Func then Avoid to toggle Close Call modes. • Press Func then press and hold Avoid to enable Close Call Only mode.
List/Services	<ul style="list-style-type: none"> • Press to select Lists to monitor. • Press Func then list to select Service Types.
System	<ul style="list-style-type: none"> • Press Func then System to start Scan mode. • Press to enter System Pause for 2 seconds then hold on a System in Scan mode. • Double-press System for hold without pause in Scan mode. • Double-press to release System Hold. • Press to enter Search Pause mode for 2 seconds then hold on a Search in Search mode. • Double-press for Search Hold without pause in Search mode. • Press to release Search Hold.
Department	<ul style="list-style-type: none"> • Press to enter Department, pause for 2 seconds, and then hold on a Department in Scan mode. • Double-press Department for hold without pause in Scan mode. • Double-press to release Department Hold. • Press to enter Search Pause mode for 2 seconds then hold on a Search in Search mode. • Double-press for Search Hold without pause in Search mode. • Press to release Search Hold. • Press Func then Department to hold/release Site in Scan mode.
Channel	<ul style="list-style-type: none"> • Press to hold/release a Channel, Frequency, CC hit, Tone-Out. • Press Func then Channel to toggle Modulation for Channel, Site, or Search, in Hold modes. • Press to pause in Replay mode.
Menu	<ul style="list-style-type: none"> • Press to enter Menu mode. • Press to return one level in Menu mode. • Press Func then Menu for Search menu in Search mode. • Press Func then Menu for Close Call menu in Close Call mode. • Press Func then Menu for Tone-Out menu in Tone-Out.

Replay/Record	<ul style="list-style-type: none"> • Press to Replay the last transmissions. • Press Func then Replay to start/stop recording • Press and hold to Review Recordings.
Number keys	<ul style="list-style-type: none"> • Press to select Favorites Lists in Scan mode. • Press 0-9 to use direct entry in Hold mode. • Press 0-9 to toggle custom search bands on or off in Custom Search mode. • Press 0-6 to toggle Close Call bands on or off in Close Call mode. • Press Func then 1, 2, or 3 to enable search keys in Hold mode. • Press 4(<ATT) to move the cursor to the left when editing text. • Press Func then 4(<ATT) to toggle channel/search/CC attenuation on/off in-Hold mode. • Press Func then press and hold 4(<ATT) to toggle Global Attenuation on/off in-Hold mode. • Press 6(>) to move the cursor to the right when editing text. • Press Func then press and hold 6(>) to enter Weather Scan. • Press Func then 7(IFX) to toggle intermediate frequency exchange for a channel/frequency in Hold modes. • Press Func then press and hold 8(REV) to view the repeater frequency in-Search mode. • Press Func then 9(DISP) to toggle 3-Line Display mode on/off in Scan Hold mode. • Press Func then 0(LVL) to toggle the volume offset for a channel in Scan Hold mode.
./no/PRI	<ul style="list-style-type: none"> • Press to enter a decimal point for a frequency. • Press to delete current character with Data Naming/Direct Entry. • Press to cancel Confirm? prompt. • Press twice to delete all characters with Data Naming/Direct Entry. • Press twice to enter a hyphen when entering an ID. • Press to enter an 'i' when entering an I-Call ID. • Press Func then ./no to toggle Priority modes in Scan mode.
E/yes Q. SRCH	<ul style="list-style-type: none"> • Press to select a menu item or save an entry in Menu mode • Press to store a blinking CTCSS/DCS/NAC tone in Scan mode. • Press to store an ID in ID Search mode in Scan mode. • Press for Advanced Channel Menu in Hold/Receive modes. • Press to 'quick store' a frequency in Search modes. • Press Func then E/yes to start Quick Search mode. • Press Func then E/yes to toggle ID Search mode on/off in Scan mode (when scanning Trunked System in Favorites List only). • Press to store found tones in Tone-out Search mode. • Press to select the current Tone-Out menu in Tone-Out mode.

SET YOUR LOCATION AND RANGE

Press **Menu** then scroll to Set Your Location and press **E/yes**.

Scroll to through the following option and press **E/yes**.

SET LOCATION

Set Manual Location – This will set your exact location and a default scan range of 0 kilometer. You can then edit the location name and save the location.

Input Latitude. Using the keypad, enter your latitude.

Press **.no** to toggle N or S, and press **E/yes**.

Input Longitude. Using the keypad, enter your longitude.

Press **.no** to toggle E or W, and press **E/yes**.

Set Up GPS – Sets the location format, serial port baud rate, and units.

Location Format

DMS:DDD°MM'SS.ss or DEG:DDD.dddddd.

Set Serial Port. Default is 4800 bps for GPS device.

Off, 4800, 9600, 19200, 38400, 57600, or 115200 bps.

SET RANGE

Set Range – This setting allows you override the default range setting for your current location to increase or decrease the number of Trunking Sites and Channel Departments you can receive when you are scanning from the Full Database and when you are scanning Favorites Lists with Location Control enabled. See also Understanding Range.

Enter the range (0-80km) and press **E/yes**.

UNDERSTANDING RANGE

1. The range setting will only work with Favorites Lists that have Location Control set to On and with Departments/Sites that have locations programmed. If you manually program Departments/Sites with no location information included, the range setting will have no effect on them because the scanner doesn't know where they are.
2. You will receive Departments/Sites that have a range equal to your scan range setting plus the programmed range of the Departments and Sites. For example, if your scan range is set to 16 kilometers and a Department/Site range is set to 48 kilometers, and that Department/Site is less than 64 kilometers away from your current location setting, it will be enabled in your Favorites List according to both range settings.

EDIT LOCATION

This allows you to create a location or edit a location for rapid recall.

New Location or Edit Location

Edit Name. See Data Naming.

Use Location. This will set the location as current for scanning the Database and Favorites Lists with Location Control enabled.

At Confirm? Press **E/yes** or **.no**.

Delete Location. You can only delete saved locations. The last location set will be retained for use when scanning the Database.

At *Confirm Delete?*, press **E/yes** or **.No**.

Set Location Information. See Set Manual Location.

Set Range. Enter the range (0-80km) and press **E/yes**.

Save Location – This will save the current location, the range, and set the location as current for scanning the Database and Favorites Lists with Location Control enabled.

See Data Naming to name the location.

SELECTING SERVICE TYPES

Not all service types are enabled when you set your location in the scanner. By default only Custom 1 is enabled.

The Appendix has a list of Service Types and their general descriptions.

Press **Func** then the Zip/Services button.

Scroll to each Service Type and press **E/yes** to enable or disable.

Press **System** to exit.

When the scanner displays a Service Type that is not in the Favorite Lists, the scanner will display a “---” indication.

NAVIGATING THE MENUS

The **Menu** key lets you select options to set up and use the scanner. To select a menu item, rotate the scroll control. Rotate right for down and left for up.

The currently-selected menu item is highlighted and reversed in the display. When the menu item you want to select is highlighted, press **E/yes** or the scroll control to select it. To back up a level, press **Menu**.

To exit all menus and return to the previous mode, press **Avoid**.

DATA NAMING

Name any Favorites List, System, Site, Department, Channel, Location, Custom Search, Recording Session, Tone-Out, or SAME group using up to 64 characters.

To Enter a Character, turn the scroll control until the character you want appears.

To move the cursor to the right, press 6(>).

To move the cursor to the left, press 4(<ATT).

To clear a character, press **./no**.

To clear all characters, press **./no** twice.

Press **E/yes** when finished to exit.

DISPLAY MENU

Press **Menu** and then scroll to Display Options and press **E/yes**.

Scroll to the options below and press **E/yes**.

Set Backlight	Set ID Format (MOT/P25)
Adjust Contrast	Set ID Format (EDCS)
Disp. Unit ID	

Setting the Backlight – The scanner will turn on/off the LCD and the Keypad backlight automatically according to backlight setting.

Set Mode

Squelch

Off - The backlight stays off when the squelch opens.

5 sec - The backlight stays on 5 seconds after the squelch opens.

10 sec - The backlight stays on 10 seconds after the squelch opens.

Open Squelch - The backlight stays on only when the squelch is open.

Keypress

Off - The backlight stays off when any key is pressed.

5 sec - The backlight stays on for 5 seconds when any key is pressed.

10 sec - The backlight stays on for 10 seconds when any key is pressed.

Timeout

10 sec - Turns the backlight on for 10 seconds when you press **⏏/⏏** .

30 sec - Turns the backlight on for 30 seconds when you press **⏏/⏏** .

60 sec - Turns the backlight on for 30 seconds when you press V/O .

Infinite - The backlight always stays on.

Set Dimmer

High, Middle, or Low

Adjust Contrast – This setting controls the displays contrast.

Contrast 1-15

Display Unit ID – Allows you view the unit ID of the radio currently transmitting on Motorola, EDACS, and APCO P25 systems.

On or Off

Set ID Format – Sets the ID display format for the System.

Set ID Format (Mot/P25)

Decimal Format or Hex Format. The default setting is **Decimal**.

Set ID Format (EDACS)

AFS Format or Decimal Format. The default setting is **AFS**.

View the Battery Level

To view the battery level (in volts) press the scroll control and look at the small numbers in the upper right of the display. Press the scroll control again to close the battery level or let it disappear after 10 seconds.

A Look at the Display

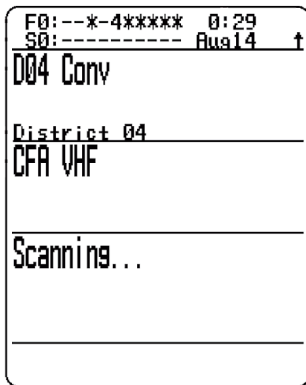

Scan Mode

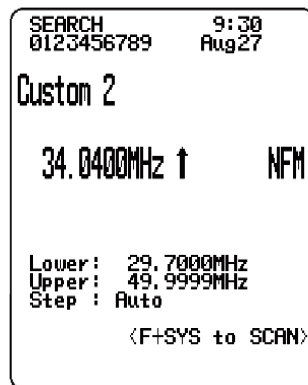

Searching

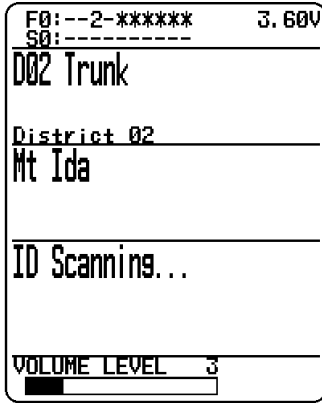

Volume

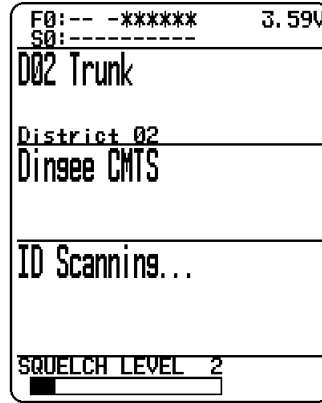

Squelch

	Displays to show Function mode.
F0-9	Indicates the first digit of the Favorites List quick key on the left with the blinking second digit on the right in Scan mode. A non-blinking number on the right indicates the quick key is enabled waiting to be scanned. A - (dash) means nothing is assign to the quick key. An * (asterisk) means the quick key is disabled.
SITE HOLD	Displays in Site Hold mode.
SEARCH	Displays in Search mode.
Time	Displays the time.
↑ or ↓	Displays to show the Scan or Search direction.
GPS	Displays when connected to a GPS unit.
REC	Displays when recording.
	Displays to show the signal strength.
PRI	Displays in Priority mode.
	Displays in reverse in Priority DND mode.
	Displays and blinks if the battery is low.
	Displays if the Close Call Priority feature is on.
	Displays in reverse in Close Call DND mode.
S=NN	Displays the squelch level for three seconds when you turn SQ.
Battery Level	Displays when you press Scroll Control knob.

S0-9	<p>Display the first digit of the current System quick key on the left with the blinking second digit on the right.</p> <p>A non-blinking number on the right indicates the quick key is enabled waiting to be scanned.</p> <p>A - (dash) means nothing is assigned to the quick key.</p> <p>An * (asterisk) means the quick key is disabled.</p> <p>0-9 displays the Custom Search key status in Search mode.</p>
Date	Displays the date.
Receive Mode	Receive mode in Function mode.
Volume Offset	Volume Offset for the channel in Function mode.
IFX	Displays if Intermediate Exchange is enabled for the channel.
ATT	<p>Displays to show channel attenuation in Receiving/Hold modes and in Search mode to show search attenuation.</p> <p>ATT blinks to indicate global attenuation.</p>
P25	Displays if the channel is receiving digitalized voice in Receiving or Hold modes.
LNK	Displays when data is received on a voice channel in Receiving or Hold modes.
DAT	Displays when data is received on a control channel in Receiving or Hold modes.
ENC	Displays if the channel is receiving encrypted voice and is muted in Receiving or Hold modes.
PT0/PT1	Phase 2 voice and slot information.
PX0/PX1	X2-TDMA voice and slot information.
PRV	This icon shows the receiving digitized voice of EDACS ProVoice. Then, this shows in the same place as "P25"
CAP	Capacity Plus/Linked Capacity Plus site voice and data in MOROTRBO system.
CON	Connect Plus site voice and data in MOTOTRBO system.
DT3	Trunked DMR site voice and data in ETSI Standard Tier 3 system.
DMR	One Frequency DMR site voice and data/Simplex DMR voice.
XPT	Hytera XPT site voice and data in MotoTRBO system. These show in the same place as "P25" icon, and also in conventional/search mode.
S1/S2	This icon appears TDMA Slot 1 and Slot 2 in DMR/MOTOTRBO system.
V=NN	Displays the volume level for three seconds when you turn VOL .
System Name Avoid/Hold	<p>Displays in Receiving/Hold modes.</p> <p>Temporary avoids appear reversed - AVOID.</p>
Search with Scan	Displays to show a custom search in Scan mode.
Custom Search Name	Displays in Search mode.
Department Name Avoid/Hold	<p>Status displays in Receiving/Hold modes.</p> <p>Temporary avoids appear reversed - AVOID.</p> <p>Displays for a conventional system in Scan mode.</p> <p>Displays for a system in Receiving/Hold modes.</p>

Custom Search Name	Displays in Search with Scan mode.
Site Name	Displays for a trunked system in Scan mode.
Department Name	Displays the Department Name.
Search Frequency	Displays in Search mode.
Modulation	Displays in Search mode.
Scanning	Displays for a conventional system in Scan mode.
ID Scanning/ Searching	Displays for a trunked system in Scan mode.
Channel Name	Displays in Receiving/Hold modes.
P	Displays when receiving a priority channel in Receiving/Hold modes.
Channel Service Type	Displays in Receiving/Hold modes.
TGID	Displays in Receiving/Hold modes for a trunked site with Display Unit ID set to On.
Tone/Code	Displays for a conventional channel in Receiving/Hold modes. Blinking Tone/Code indicates a Tone/Code search. ***** indicates Tone/Code lockout.
Channel Name Avoid/Hold	Displays a channel's Avoid/Hold status. Temporary avoids appear reversed - AVOID .
Unit ID	Displays in Receiving/Hold modes for a trunked site with Display Unit ID set to On.
TGID	Displays in Receiving/Hold modes for a trunked site with Display Unit ID set to Off.
Frequency, Modulation	Display for a conventional channel in Receiving/Hold modes.
Favorites List Name	Displays in Scan mode.
SCR	Displays if one or more broadcast/custom screen bands are turned on in Receiving/Search mode.
REP	Displays if Repeater Find is enabled in Receiving Search modes.
Number Tag Information	Displays in Function mode for a Favorites List.
D0-9	When you press Func. , the screen displays the first digit of the current Department quick key on the left with the blinking second digit on the right. <ul style="list-style-type: none"> • A non-blinking number on the right indicates the quick key is enabled, waiting to be scanned. • A - (dash) means that nothing is assigned to the quick key. • An * (asterisk) means the quick key is disabled.

SETTINGS MENU

Press **Menu** then scroll to Settings and press **E/yes**.

Scroll to the options below and press **E/yes**.

Adjust Key Beep

Auto Shutoff

Restore Options

Battery Option

Set Clock

See Scanner Information

Band Defaults

Replay Options

Keypad Lock

Adjust Key Beep

Allows you to turn the key beep on or off and adjust the volume level.

Auto sets the alert beep to the master volume level.

Off, Level 1-15, or Auto

Battery Option

Set Battery Save. On or Off.

Set Charge Time. 1-14 (hours). See also Using Rechargeable Batteries.

Set Battery Low

Set Alert

Set Alert Tone. Change tone frequency. (640 Hz, 780 Hz, 920 Hz, 1060 Hz, 1200 Hz)

Set Alert Interval. Set to a value between 1 and 60 seconds. (Default is 15 sec.)

Set Alert Volume. 1-15, Off, or Auto. (Default is Auto)

Set Voltage. 3100 - 3400mV. (Default is 3300mV)

Band Defaults

Use this menu to change the default modulation and frequency step or spacing used for each band.

Scroll to each band you wish to edit and press **E/yes**. See also Default Bands.

Set Modulation

AM, NFM, FM, WFM, or FMB (Broadcast).

Set Step

5, 6.25, 7.5, 8.33, 10, 12.5, 15, 20, 25, 50, or 100 kHz.

Auto Shutoff

Allows you to set the scanner to shut off after a set time.

Off, 5, 10, 15, 30, 45 min, 1, 2, 3 hours.

Set Clock

Sets the clock for the display and the default tag for recordings.

Set Date

Set Year. Enter the year (2013-2099).

Set Month. Enter the month.

Set Day. Enter the day.

Set Time

Set Hour. Enter the Hour (0-23).

Set Minute. Enter the minute.

Set Time Zone

Scroll to your time zone.

Set Daylight Saving

On or Off

Replay Options

This allows you to set the recording duration and delete, replay, or rename recording sessions.

Set Replay Duration

30, 60, 90, 120, 150, 180, 210, or 240 sec.

Review Recordings

Recording Session

Play Session. See *Replaying Transmissions*.

Delete Session

At Confirm Delete? Press **E/yes** or **./no**.

Rename Session. See *Data Naming*.

Restore Options

Allows you to clear all user data (full reset) or reset just scanner settings to default.

Clear User Data

(Full Reset) will delete all Favorites Lists, locations, reset all profile options to default, clear all Avoids, delete all recording sessions, all discovery logs, and all weather event records.

Note: Pressing and holding 2, 9, and Dept when you power on the scanner will also clear all user data.



Reset User Settings

Will only reset all scanner settings; the Favorites List will be saved.

See Scanner Information

This will show you how much memory is in use, the firmware version, and scanner serial number.

Keypad Lock

The only keys/knobs that work when the keypad is locked are **Channel** for hold mode, /   , **Func**, and the Scroll Control for volume.

Press **Func** then /   to toggle the keypad lock.

KEY CONCEPTS

QUICK KEYS

Organizing your Quick Keys will be part of the planning. You will have to figure out which quick keys to assign to your Favorites Lists, Systems, and Departments so you can scan them without a table of contents and with some sort of logic you can remember. Remember, enabling/disabling quick keys is not the same thing as Avoiding or Unavoiding Systems/Department and Monitor On/Off Favorites Lists.

FAVORITES LIST QUICK KEYS

Favorites Lists Quick Keys are used to enable or disable Favorites Lists for scanning. They are just the number keys on the scanner but once assigned to a Favorites List they become the Quick Keys. Your Favorites Lists hold your Systems that also may have System quick keys assigned to those Systems. You cannot assign a Quick Key in one Favorites List to another Favorites List. Selecting a Favorites List will enable all (Unavoided) Systems in that list for scanning. There are 100 Quick Keys (0-99) to use for your Favorites Lists. Favorites List Quick Keys can only be assigned once to any one Favorites List, If you don't assign a Quick Key to a list, it will always be enabled.

SYSTEM QUICK KEYS

System Quick Keys are used to enable or disable conventional and trunking systems for scanning. You can assign any quick key to one or more Systems, or program one or more systems with no quick key assigned that will always be scanned unless you Avoid it. There are also 100 Quick Keys (0-99) to use for your Systems.

DEPARTMENT QUICK KEYS

Department Quick Keys enable or disable conventional and trunking systems for scanning.

You can assign any quick key to one or more Departments, or program one or more Departments with no quick key assigned so that these Departments will always be scanned unless you Avoid it. There are also 100 Quick Keys (0-99) to use for your Departments.

It is best to assign Quick Keys to everything to easily access your Favorites List and System/Department. See also Scanning and Quick Key scanning order.

SEARCH KEYS

You can assign any Search Keys (1, 2, or 3) to any Custom Search range, Tone-Out Search, or Close Call Only Search for quick access to your favorite searches.

PLANNING PROFILES

STARTUP KEYS

You can program each of your Favorites Lists with a Startup Key (0-9) so that when you power up the scanner and press the key number, just those Favorites List(s) assigned to the key will be enabled for scan. Systems are not affected.

NUMBER TAGS

Numbers tags will allow you to tag each Favorites Lists, System, and Channel to locate easier. Number tags can range from 0 to 99 for Favorites Lists and Systems and 0-999 for Channels. You can assign number tags to channels even if the Favorites List does not have a number tag but, without a Favorites List number tag, you can only navigate to these channels while holding or scanning in that Favorites List. See also Using Number Tags.

ALERTS

You can program your scanner to alert you when, a Channel or Unit ID is received, you receive a Close Call hit, an ID is transmitted with an Emergency Alert or you receive a Tone-out hit. For each alert in the scanner, you can select from 9 different tone patterns, 15 volume settings, 7 colors, and 3 color patterns.

MANAGING FAVORITES LISTS

Favorites Lists hold all your Systems, Sites, Departments, and Channels. You should assign a Quick Key to every Favorites List to quickly enable or disable the list. You can assign a Favorites List to a Favorites List Quick Key.

NEW FAVORITES LIST/ FAVORITES LIST OPTIONS

Press **Menu** then scroll to Manage Favorites and press **E/yes**.

To Create a New Favorites List, scroll to New Favorites List and press **E/yes**.

To Edit a Favorites List, scroll to the Favorites List and press **E/yes**.

Scroll to the options below and press **E/yes**.

Review/Edit System	Stop All Avoiding
Set FL Quick Key	Rename
Set FL Number Tag	Delete
Det FL Startup Key	Information
Use Location Control	
Review Avoids	

Review/Edit System – See Programming Systems.

Set FL Quick Key – This assigns a quick key to the Favorites List and will scan the list when the key is enabled. The default setting is . (no quick key). If you don't assign a Favorite Lists to a quick key, it will always be scanned unless you turn it off in Select Lists to Monitor. See also Select Lists to Monitor.

Scroll to the quick key number (0-99 or . for no quick key) and press **E/yes** to save.

Note: Pressing the first number of a 2-digit quick key will get you closer, 1 for 10, 2 for 20, etc., then scroll to second digit.

Set FL Number Tag – This allows you to number a Favorites List so you can access it quickly from scan hold mode.

The default setting is no number tag. See also Using Number Tags.

Enter the number tag (0-99) and press **E/yes** to save. Enter a blank for no number tag.



Set FL Startup Key – This allows you to turn on the scanner with the Favorites List enabled for scan. The default settings are all keys Off.

See also Using Startup Keys.

Scroll to each key (0-9) and press **E/yes** to enable then press **Menu** to save.

Use Location Control – This enables Location Control for the Favorites List. The default setting is Off. See also Understanding Location Control.

Review Avoids – This allows you to review all Avoids for the Favorites List. Temporary Avoids appear reversed in the display - **AVOID**.

Scroll to each Avoided channel, Department, or System, and press **E/yes** to Stop Avoiding.

Stop All Avoiding – This will Stop Avoiding all Channels, Departments, and Systems in the Favorites List.

At Confirm Delete? Press **E/yes** or **./no**.

MANAGING FAVORITES LISTS

Rename – This allows to you rename the Favorites List.

See Data Naming.

Delete – This will delete the Favorites List.

At Confirm Delete? Press **E/yes** or **./no**.

Information – This will show you the file size and number of Systems in the list.

UNDERSTANDING LOCATION CONTROL

Location Control allows you to enable or disable channels scanned in a Favorites List based on your location. Actually, it enables/disables Sites and Departments in Favorites Lists (as long as they have locations programmed) based on your current location and scan range settings. Location Control is always enabled when scanning from the Full Database.

To use Location Control, you have to enable it for each Favorites List (default is **OFF**). You also need to have locations programmed for Sites and Departments in each list (you can't program a location for a system).

With Location Control set to **ON**, the scanner only sees Departments/Sites with programmed locations. Any Department/Site with no location information programmed will not be scanned. If you append (add) a System/Department to a list from the database, the locations will be brought in with each System/Department you append.

With Location Control set to **OFF**, the scanner will enable all Sites and Departments in your Favorites List no matter what the scan range or Site/Department range is set to.

You don't need a GPS to scan by location if all of the following apply:

1. You have Location Control set to **ON** for each Favorites List you want to use with Location Control.
2. You set manually or select a location.
3. Your Departments and Sites have locations programmed.

The scanner then compares your location data with Site and Department data to determine which channels to scan.

Conceivably, you could program everything you want to hear into one Favorites List and scan just by selecting locations rather than enabling/disabling lists. If you are traveling long distances a GPS device would be a better way to go.



PROGRAMMING SYSTEMS

Note for Motorola/P25 systems: If you are not sure if the system is Motorola or P25, look at the system type in the RR database for your system. Only those systems tagged as “Project 25 Phase 1 or Project 25 Phase 2” are Project 25 systems. Any system type that includes the word “Motorola” should be programmed as a Motorola system, even if it uses some or all digital channels.

NEW SYSTEM/SYSTEM SETTINGS

Press **Menu** then scroll to Manage Favorites and press **E/yes**.

Scroll to the Favorites List and press **E/yes**.

Scroll to Review/Edit System and press **E/yes**.

To Create a New System, scroll to **New System** and press **E/yes**.

Scroll to **P25 Trunk**, **P25 X2-TDMA**, **P25 One Frequency**, **Motorola**, **MOTOTRBO Trunk**, **DMR One Frequency**, **EDACS**, **LTR**, or **Conventional** and press **E/yes**.

At **Confirm?** press **E/yes** or **.no**.

To Edit System Settings, scroll to the **System** and press **E/yes**.

SYSTEM SETTINGS

Edit Name	Copy System
Edit Unit ID	Edit System

Edit Name – Enter a name and press **E/yes**. See Data Naming.

Edit Unit IDs – Unit ID must be set to On in the Display Options menu to view Unit IDs.

New Unit ID/Edit Unit ID

Enter the Unit ID and press **E/yes**.

Edit Name See Data Naming.

Set Alert Tone

Alert 1-9 or Off.

Set Level

Level 1-15 or Auto (the master volume level).

Set Alert Light

Set Color

Off, Blue, Red, Magenta, Green, Cyan, Yellow, or White.

Set Pattern

On, Slow Blink, or Fast Blink.

Delete Unit ID

At **Confirm Delete?**, press **E/yes** or **.no**.

New Unit ID

See New Unit ID.

Copy System – Copying a system will copy all Sites, Departments, Channels, and settings including quick key assignments into the current Favorites List.

See Data Naming to name the new system.

Delete System

At **Confirm Delete?**, press **E/yes** or **.no**.

SYSTEM OPTIONS

Press **Menu** then scroll to **Manage Favorites** and press **E/yes**.

Scroll to the **Favorites List** and press **E/yes**.

Scroll to **Review/Edit System** and press **E/yes**.

Scroll to the **System** you want to edit and press **E/yes**.

Scroll to **Edit Sys Option** and press **E/yes**.

Note: Not all options will appear for all types of systems.

Set Quick Key	Priority ID Scan	Clear All ID Avoids
Set Number Tag	Set Status Bit	Set Audio AGC
Set Avoid	Set End Code	P25 NAC Option
Set Hold Time	Emergency Alert	Digital Waiting Time
ID Search	Review ID Avoids	Digital Threshold Mode
Edit Fleet Map		Digital Threshold Level

Set Quick Key – This assigns a quick key to the System and the scanner will scan the System when the key is enabled. The default setting is . (no quick key). If you don't assign a Quick Key to a system, it will always be scanned unless you Avoid it.

0-99 or . for no quick key.

Note: Pressing the first number of a 2-digit quick key will get you closer, 1 for 10, 2 for 20, etc., then scroll to second digit.

Set Number Tag – This allows you to number a System so you can access it quickly from Scan Hold mode.

The default setting is no number tag. See also Using Number Tags.

Enter the number [**0-99**, Blank (no number tag)] and press **E/yes** to save.

Set Avoid – This determines whether a System will be scanned or not (even if the system is enabled). Temporary Avoids cancel when you cycle power.

The default setting is **Stop Avoiding**.

Stop Avoiding, Temporary Avoid, or Permanent Avoid

See also Scan Avoids.

Set Hold Time – This sets (in seconds) the amount of time the scanner will scan the System before moving on to the next system. All (Unavoided) channels will be scanned at least once regardless of this setting. The scanner moves to the next system after the hold time expires, any current transmission ends, and the channel delay time expires. The default setting is **0** seconds.

Enter the hold time and press **E/yes** to save.

0-255

ID Search – This sets whether the scanner searches for all IDs in a trunking system (**On**), or scans only programmed IDs (**Off**).

The default setting is **Off**. See also ID Toggle ID Scan or Search.

On or Off

Edit Fleet Map (Motorola Type I/II systems Only) – This allows you to program a fleet map for Motorola Type I Systems. You must program a system fleet map in order for the scanner to properly track and display talk group IDs.

Block 0 Scroll to the size code (0-14) and press **E/yes**.

The next available block is prompted to select the next size code (0-14).

Repeat for each block as needed (0-7).

Note: If you select size code 12, 13, or 14, these restrictions apply:

12 can only be assigned to Blocks 0, 2, 4 or 6.

13 can only be assigned to Blocks 0 and 4.

14 can only be assigned to Block 0.

Since these size codes require multiple blocks, you will be prompted for the next available block. Example: If you assign Block 0 as 12, the scanner prompts you for block 2, the next block available, instead of block 1.

Priority ID Scan (no P25 One Freq) – This allows you to use Priority Scan with IDs in the System. The default setting is **Off**.

On or Off

Set Status Bit (Motorola Only) – This sets how your scanner works with Status Bits (also called S-bits), letting you control how the scanner interprets and displays Motorola talk group IDs. The default setting is **Ignore**.

Yes. The scanner treats all received IDs as unique IDs.

Ignore. The scanner rounds all received IDs down to the next interval of 16.

Set End Code (Motorola Only) – This sets how the scanner handles the transmission end code sent by most Motorola Systems.

The default setting is **Analog**.

Analog. The scanner recognizes only analog end transmission codes.

Analog+Digital. The scanner recognizes both analog and digital end codes.

Ignore. The scanner waits for the carrier to drop before leaving a channel.

Emergency Alert (Motorola/EDACS Only) – This sets how your scanner alerts you to IDs that have the emergency flag set. The default setting is **Off**.

Set Alert Tone

Alert 1-9 or Off.

Set Level

Level 1-15 or Auto (the master volume level).

Set Alert Light

Set Color

Off, Blue, Red, Magenta, Green, Cyan, Yellow, or White.

Set Pattern

On, Slow Blink, or Fast Blink.

Review ID Avoids – This allows you to review Avoided IDs in the System. Temporary Avoids appear reversed in the display: **AVOID**.

Stop Avoiding? Scroll to ID and press **E/yes** to Stop Avoiding.

Nothing Avoided appears if nothing is Avoided.

Clear All ID Avoids – This allows you to Stop Avoiding all Avoided IDs in the System.

At **Confirm?**, press **E/yes** or **./no**.

Nothing Avoided appears if nothing is Avoided.

Set Audio AGC – This allows you to turn AGC (Automatic Gain Control) on or off for the System. The default settings are **Off**.

Analog - Press **E/yes** to toggle **On** or **Off**.

Digital - Press **E/yes** to toggle **On** or **Off**.

P25 NAC Option (P25 One Freq) – This allows you to have the scanner search for NAC codes or you can program a specific code for the System.

The default setting is **Search**.

Search. The scanner opens squelch for any digital signal and displays the NAC being used.

Set P25 NAC. The scanner opens squelch only for signals that include the programmed NAC.

At **Input P25 NAC**, see Data Naming.

Digital Waiting Time (Conventional Only) – This setting gives the scanner time to determine if channels on Conventional Systems have digital or analog transmissions. During this time, the scanner will evaluate the received signal and, if it detects digital data, will open squelch immediately. If digital is not detected before the delay expires, the scanner will open squelch at the end of this delay. This is to prevent “false decode” problems. This setting only affects conventional channels with an Audio Type set to **All**. The default setting is **400** ms.

0 to **1000**

Note: Any analog transmissions will lose the first part of the transmission, up to the wait time you set here.

Digital Threshold Mode – (Conventional Only)

The default setting is **Auto**.

Auto. Automatically sets the decode threshold based on the received signal.

Manual. Allows you to manually set the threshold in threshold setting mode by using the Digital Threshold Level setting.

Default. Sets the scanner to the default threshold of 8, Auto.

Digital Threshold Level (Conventional Only) – The default setting is **8**.

0 to **20**

PROGRAMMING SITES

NEW SITE/SITE OPTIONS

Press **Menu** then scroll to **Manage Favorites** and press **E/yes**.

Scroll to the **Favorites List** and press **E/yes**.

Scroll to **Review/Edit System** and press **E/yes**.

Scroll to the **System** and press **E/yes**.

Scroll to **Edit Site** and press **E/yes**.

To Create a New Site, scroll to New Site and press **E/yes**.

To Edit an Existing Site, scroll to the Site and press **E/yes**.

Note: Not all options will appear for all sites.

Edit Name	Set Modulation	Digital Threshold Mode
Set Site Type	Set Attenuator	Digital Threshold Level
Edit Band Plan	Set Avoid	Delete Site
Set Frequencies	Set Location Information	New Site
	Digital Waiting Time	

Edit Name

See Data Naming.

Set Site Type (EDACS Only) – EDACS Wide is the same as EDACS Standard and use a 9600 baud control channel. EDACS Narrow-band sites use a 4800 baud control channel.

Wide (Standard) or Narrow. The default setting is **Wide**.

Edit Band Plan (Motorola/P25 Only) – Band plans are required so the scanner can correctly determine the voice channel frequencies.

P25 Systems. Explicit mode systems (which comprise most systems in use) include all information needed to determine voice frequencies on the control channel, leave all entries blank. The system will automatically detect the band plan and fill in the entries. Implicit systems need you to supply the systems band plan with the **Custom** option for the scanner to correctly determine voice frequencies.

Select Plan - Scroll to each **Band Plan 0-9, A-F**, and press **E/yes**.

Input Base Freq - Enter the base frequency press **E/yes**.

Input Spacing - Enter the step size and press **E/yes**.

Press **Menu** to return and repeat for each band plan as needed.

Motorola Systems

800/900 Standard or 800 Splinter

The scanner will use the regular Motorola band plan.

Custom Motorola/VHF/UHF Systems. Custom band plans require that you enter both a lower and an upper base frequency value. The lower base frequency (or base) is always the base frequency as provided in the Radio Reference Database.

Use this Excel spreadsheet to calculate the upper base frequency value located at:
<http://info.uniden.com/twiki/pub/UnidenMan4/CalculatingUpperBaseFrequencies/CustomBandPlanCalculator.xls>

If you don't have Excel you can download and install a viewer here, or do a simple Google search.

The upper base frequency can also be found using the Band Plan Calculator located at:
<http://info.uniden.com/twiki/bin/view/UnidenMan4/CalculatingUpperBaseFrequencies>.

Also, look at Determining Base/Step/Offset for VHF/UHF Motorola Systems at Radio Reference.com.

Select Plan 1-6 Select for each Band Plan.

Set Base Freq

Input Lower. Enter the lower base frequency and press **E/yes**.

Input Upper. Enter the upper base frequency and press **E/yes**.

Set Offset

Input Offset. Enter the offset and press **E/yes**.

Select Polarity. Scroll to + (default) or - and press **E/yes**.



Set Spacing. Scroll to the step size and press **E/yes**.

Press **Menu** to return and repeat for each band plan as needed.

Set Frequencies – This is where you program trunking frequencies for the Site.

New Frequency/Edit Frequency. Enter the frequency and press **E/yes**.

For EDACS and LTR sites only:

Input LCN. Enter the LCN number and press **E/yes**.

Delete Frequency

At **Confirm Delete?**, press **E/yes** or **./no**.

Set Modulation (no P25/P25 One Freq) – This setting selects the modulation used for the Site. The default setting is **Auto**.

Auto, NFM, or FM

See also Scan Modulation.

Set Attenuator – This setting controls whether the scanner attenuates signals on the Site by about 20 dB The default setting is **Off**.

On or Off

See also Scan Attenuation.

Set Avoid – This determines whether a Site will be scanned or not. Temporary Avoids cancel when you cycle power. The default setting is **Stop Avoiding**.

Stop Avoiding, Temporary Avoid, or Permenant Avoid

See also Scan Avoids.

Set Location Information – This allows you program a location for the Site to use with Location Control enabled or with a GPS. You can program a circle with a radial range or multiple rectangles as a location.

See Set Up GPS first to set your location format and the Baud rate.

Circle

Set Latitude

Enter the latitude. Press **./no** to toggle **N** or **S**, and press **E/yes**.

Set Longitude

Enter the longitude. Press **./no** to toggle **E** or **W**, and press **E/yes**.

Set Range See also Understanding Range.

0-6000

Rectangles

New Rectangle

Latitude - Top Left

Enter the latitude. Press **./no** to toggle **N** or **S**, and press **E/yes**.

Longitude - Top Left

Enter the longitude. Press **./no** to toggle **E** or **W**, and press **E/yes**.

Latitude - Bottom Right

Enter the latitude. Press **./no** to toggle **N** or **S**, and press **E/yes**.

Longitude - Bottom Right

Enter the longitude. Press **./no** to toggle **E** or **W**, and press **E/yes**.

Stored Rectangle

Edit Rectangle See Rectangles above.



Delete Rectangle

At **Confirm Delete?** press **E/yes** or **./no**.

Digital Waiting Time (Motorola Only) – This setting gives the scanner time to determine if channels on mixed Motorola Systems have digital or analog transmissions. During this time, the scanner will evaluate the received signal and, if it detects digital data, will open squelch immediately. If digital is not detected before the delay expires, the scanner will open squelch at the end of this delay. This is to prevent “false decode” problems. This setting only affects channels with an Audio Type set to **All**. The default setting is **400** ms.

0 to 1000

Note: *Any analog transmissions will lose the first part of the transmission, up to the wait time you set here.*

Digital Threshold mode (P25/Motorola/MOTOTRBO)

The default setting is **Auto**.

Auto. Automatically sets the decode threshold based on the received signal.

Manual. Allows you to manually set the threshold in threshold setting mode by using the Digital Threshold Level setting.

Default. Sets the scanner to the default threshold of 8, Auto.

Digital Threshold Level (P25/Motorola/MOTOTRBO) – The default setting is **8**.

0 to 20

Delete Site – Deletes the Site.

At **Confirm Delete?** press **E/yes** or **./no**.

New Site – See New Site.

PROGRAMMING DEPARTMENTS

NEW DEPARTMENT/DEPARTMENT OPTIONS

Press **Menu** then scroll to **Manage Favorites** and press **E/yes**.

Scroll to the **Favorites List** and press **E/yes**.

Scroll to **Review/Edit System** and press **E/yes**.

Scroll to the **System** and press **E/yes**.

Scroll to **Edit Department** and press **E/yes**.

To **Create a New Department**, scroll to **New Department** and press **E/yes**.

To **Edit an Existing Department**, scroll to the **Department** and press **E/yes**.

DEPARTMENT OPTIONS

Edit Name	Set Location Information	Delete Department
Set Department Quick Key	Set Avoid	New Department
Edit Channel		

Edit Name

See Data Naming.

Set Department Quick Key

This assigns a quick key to the Department and the scanner will scan the Department when the key is enabled. The default setting is . (no quick key). If you don't assign a Quick Key to a department, it will always be scanned unless you Avoid it.

0-99 or . (for no quick key)

Note: Pressing the first number of a 2-digit quick key will get you closer. For example, press 1 for 10, 2 for 20, etc., then scroll to the second digit.

Edit Channel

See Channel Options.

Set Location Information – This allows you program a location for the Department to use with Location Control enabled or with a GPS. You can program a circle with a radial range or multiple rectangles as a location.

See Set Up GPS first.

Circle

Set Latitude

Enter the latitude. Press **.no** to toggle **N** or **S**, and press **E/yes**.

Set Longitude

Enter the longitude. Press **.no** to toggle **E** or **W**, and press **E/yes**.

Set Range See also Understanding Range.

0-6000

Rectangles

New Rectangle

Latitude - Top Left

Enter the latitude. Press **.no** to toggle **N** or **S**, and press **E/yes**.

Longitude - Top Left

Enter the longitude. Press **.no** to toggle **E** or **W**, and press **E/yes**.

Latitude - Bottom Right

Enter the latitude. Press **.no** to toggle **N** or **S**, and press **E/yes**.

Longitude - Bottom Right

Enter the longitude. Press **.no** to toggle **E** or **W**, and press **E/yes**.

Stored Rectangle

Edit Rectangle See Rectangles above.

Delete Rectangle

At **Confirm Delete?** press **E/yes** or **.no**.

Set Avoid – This determines whether a Department will be scanned or not. Temporary Avoids cancel when you cycle power.

The default setting is **Stop Avoiding**.

Stop Avoiding, Temporary Avoid, or Permanent Avoid

See also Scan Avoids.

Delete Department – Deletes the Department.

At **Confirm Delete?** press **E/yes** or **.no**.

New Department – See New Department.

PROGRAMMING FREQUENCIES/TGIDS

QUICKLY STORING A FREQUENCY/TGID

In scan mode press **Channel** to hold on any channel.

Enter the Frequency or TGID and press **E/yes**. See also Edit Frequency/TGID.

Note: *You have to enter a TGID/frequency in the proper format for the system you are holding on. Example: You can't enter a Motorola Type II TGID when holding on an LTR system.*

Store a Frequency/TGID into a "Quick Save" Favorites List

At **Quick Freq/TGID Save?**, press **E/yes**.

The scanner will save the Frequency/ TGID in a Favorites List called Quick Save Favorites List, in a System called Quick Save System, (with no quick keys assigned), in a Department called Quick Save Department.

Store a Frequency/TGID into a Current Favorites List

At **Quick Freq/TGID Save?**, press **./no**.

At inquiry Press **E/yes**.

At **Select Favorites List**, scroll to the Favorites List where you want to store the Frequency/TGID and press **E/yes**.

At **Select System**, scroll to the System where you want to store the Frequency/TGID and press **E/yes**.

At **Select Department**, scroll to the Department where you want to store the Frequency/ TGID and press **E/yes**.

After storing the Frequency/TGID, you will be at the Channel Options menu to complete the settings for the new channel. If you don't want to edit the channel settings press **Avoid** to return.

NEW CHANNEL/CHANNEL OPTIONS

Press **Menu** then scroll to **Manage Favorites** and press **E/yes**.

Scroll to the **Favorites List** and press **E/yes**.

Scroll to **Review/Edit System** and press **E/yes**.

Scroll to the **System** and press **E/yes**.

Scroll to **Edit Department** and press **E/yes**.

Scroll to the **Department** and press **E/yes**.

Scroll to **Edit Channel** and press **E/yes**.

To Create a New Channel, scroll to **New Channel** and press **E/yes**.

At Input **Frequency/TGID**, enter the frequency or TGID and press **E/yes**.

To Edit an Existing Channel, scroll to the **Channel** and press **E/yes**.

CHANNEL OPTIONS

Note: Not all options will appear for all channels.

Edit Name	Set Attenuator	Set Alert
Edit Frequency or TGID	Set Service Type	Set Avoid
Set Audio Type	Set Delay Time	Volume Offset
Set Number Tag	Set Priority	Delete Channel
Set Modulation		New Channel

Edit Name

See Data Naming.

Edit Frequency or TGID

Enter the frequency or TGID and press **E/yes** to save. See also Entering IDs for Partial IDs.

*To enter a Conventional Frequency, enter the **Frequency** and press **E/yes**.*

*To enter a Motorola Type II TGID, enter the **TGID** and press **E/yes**.*

*To enter a Motorola Type I TGID, enter the **Block Number** and **Fleet Number**, press **./no** twice for a hyphen, then enter the **Subfleet** and press **E/yes**.*

*To enter an EDACS ID in AFS format, enter the **Agency Number**, press **./no** twice for a hyphen, then the **Fleet** and **Subfleet** and press **E/yes**.*

*-To enter an EDACS TGID in Decimal format, enter the **TGID** and press **E/yes**.*

*To enter a LTR TGID, enter the **Area Code** (**0** or **1**) and press **./no** twice for a hyphen, then enter the **Home Repeater Number** (**01-20**) and press **./no** once, then the **User ID** (**1-254**) and press **E/yes**.*

*To enter an I-Call ID, press **./no** once then enter the **ID** and press **E/yes**.*

*To enter a Wildcard I-Call ID, press **./no** once then enter **0** and press **E/yes**.*

To enter Hexadecimal IDs, see Data Naming.

Note: If the channel is already stored in the group TGID or Frequency Exists Accept? (Y/N) appears. Press **./no to return. You can also Avoid wildcard IDs.**

Set Audio Type (Conventional/Motorola Only) – Select **All** if this channel might contain both digital and analog signals. If you are sure the channel is analog set the channel to **Analog Only**. This will prevent the Digital Waiting Time for the conventional system from losing the first part of the transmission up to the wait time you set there.

All. The scanner determines whether the audio is analog or digital.

Digital Only. The scanner will receive the channel only if it is carrying APCO 25 digital audio.

P25 NAC Option (Conventional Only)

Search - the scanner searches and displays any NAC tone received.

Set P25 NAC - allows you to program a NAC code. See Data Naming.

Note: You can also store a (blinking) NAC code when receiving the frequency in scan mode by pressing **E/yes.**

Set DMR Color Code.

Analog Only. The scanner will only receive analog audio.

Set CTCSS/DCS

Search. The scanner searches and displays any CTCSS or DCS tone.

Note: You can also store a (blinking) CTCSS/DCS tone when receiving a frequency in scan mode by pressing **E/yes**.

CTCSS. Scroll to the desired CTCSS tone. Press **E/yes** to save.

DCS. Scroll to the desired DCS tone. Press **E/yes** to save.

Set Lockout. Scroll to **CTCSS** or **DCS** and press **E/yes**.

Scroll to the desired tone you want avoided and press **E/yes** to save.

Set Number Tag – This allows you to number a Channel so you can access it quickly from scan hold mode.

The default setting is **no number tag**. See also Using Number Tags.

0-999, Blank (No number tag)

Set Modulation (Conventional Only) – This setting selects the modulation used for the channel. The default setting is **Auto**.

Auto, AM, FM, NFM, WFM, or FMB (FM Broadcast)

See also Scan Modulation.

Set Attenuator (Conventional Only) – This setting controls whether the scanner attenuates signals on the Channel by about 20 dB.

The default setting is **Off**.

On or Off

See also Scan Attenuation.

Set Service Type – This sets the Service Type for The Channel.

The Appendix has a list of Service Types and their general descriptions.

Default is **Custom 1**.

Scroll to the Service Type and press **E/yes**.

Set Delay Time – This sets (in seconds) the amount of time the scanner stays on a channel after the transmission has ended before moving to the next channel. A negative delay will force a resume after that number of seconds.

The default setting is **2** seconds.

-10, -5, 0, 1, 2, 3, 4, 5, 10, or 30 sec.

Set Priority – This sets the channel as a priority channel while scanning. The default setting is **Off**.

Note: To use **Priority ID Scan** you must also enable **Priority ID Scan for each System**. See also **Priority Scanning**.

On or Off

Set Alert – This setting controls when and how the scanner alerts you if the channel becomes active. The default setting is **Off**.

Set Alert Tone

Alert 1-9 or Off.

Set Level

Level 1-15 or Auto (the master volume level).

Set Alert Light

Set Color

Off, Blue, Red, Magenta, Green, Cyan, Yellow, or White.

Set Pattern

On, Slow Blink, or Fast Blink.

Set Avoid – This determines whether a channel will be scanned or not. Temporary Avoids cancel you cycle power. The default setting is **Stop Avoiding**.

Stop Avoiding, Temporary Avoid, or Permanent Avoid

See also Scan Avoids.

Volume Offset – This sets the Volume Offset for the Channel.

-3, -2, -1, 0, 1, 2, or 3

Note: *You can also toggle volume offset for a channel in scan hold mode by pressing Func then 0(LVL).*

Delete Channel – Deletes the Channel.

At **Confirm Delete?** press **E/yes** or **./no**.

New Channel – See New Channel.

SET SCAN SELECTION

Manage Quick Key Status – This is one way to enable or disable your System quick keys and Favorites Lists quick keys. The other way is using the number keys on the keypad. See Selecting Quick Keys.

Favorites Quick Key

Scroll to each Favorites List quick key and press **E/yes** to enable or disable.

System Quick Key

Scroll to each Favorites List and press **E/yes**.

Favorites List

Scroll to each System quick key and press **E/yes** to enable or disable.

Select Lists to Monitor – This setting enables or disables your Favorites Lists for scanning. You must first enable each list here, before you can enable the quick key for the list or you will see **Nothing to Scan**.

Note: *You will need to set a location to enable the database.*

Scroll to the **Search with Scan**, or each **Favorites List**, then press **E/yes** to enable or disable.

For Search with Scan, see also Search with Scan and Edit Custom Search.

Set All Lists Off/On – These settings turn all Favorites Lists on or off.

Select **Set All Lists Off/On** then press **E/yes** to toggle each setting.

USING STARTUP KEYS

TO USE A STARTUP KEY:

1. Turn the scanner off.
2. Press and hold the number key that corresponds to the startup key when you turn the scanner on.
3. Continue holding the number key until the scanner display shows the number of the startup key configuration

When you use Startup Configuration, the scanner checks all Favorites Lists and:

1. Favorites whose Startup Key matches the one the user pressed are changed to Monitor Status **ON**.
2. Favorites whose Startup Key **DOES NOT** match the one the user pressed are changed to Monitor Status **OFF**.

Caution: If you press the wrong key when you press the power key to set your startup configuration, and that wrong key doesn't have any Favorites Lists assigned to that key, you will start up your scanner with all systems Avoided-Nothing to Scan.

PRIORITY SCANNING

Priority Scan – When the scanner is scanning a Conventional System, it interrupts scanning, based on the Priority Interval and Max Channels settings, to check priority channels for activity. The more channels you have set to priority, the longer the interruption will be. The Favorites List(s) and System(s) containing the priority channel(s) have to be enabled (and not Avoided) or the scanner will display **Priority Scan No Channel**.

Priority ID Scan – This function is similar to conventional priority although there is no interruption during the transmission. Priority is checked in between transmissions, when the scanner is receiving the control channel, and during the channel delay period. The scanner can only look for priority IDs in the trunked system it is currently scanning.

Priority DND – The scanner checks priority channels, based on the Priority Interval and Max Channels settings, only when not receiving other conventional channels so there is no interruption in scanning with conventional systems.

The highest priority is for channels in System and Department Quick Key 0. The lowest priority is for channels in System and Department Quick Key 99. Priority for priority channels in the same channel Department follows the order in which the channels were created.

To use Priority Scan, you must first set your Priority Channels.

To use Priority ID Scan, you must also enable Priority ID Scan for each system.

*To Toggle Priority Modes, press **Func** then **.Ino(Pri)**.*

PRIORITY SCAN OPTIONS

Press **Menu** then scroll to **Priority Scan** and press **E/yes**.

Set Priority Set Interval MaxChannels/Pri-Scan

Set Priority – Sets the Priority mode. You can also toggle these modes by holding on any channel in scan mode and pressing **Func** then **.Ino(Pri)**.

Off - The Priority feature is off.

Priority DND - The scanner checks Priority channels only when not receiving other conventional channels.

PRI appears in the display reversed - **PRI**.

Priority Scan - The scanner checks conventional priority channels.

PRI appears in the display - **PRI**.

Set Interval – This sets (in seconds) how often the scanner will check the priority channels.

1-10 sec.

MaxChannels/Pri-Scan – This sets the maximum number of priority channels that are scanned during one priority scan interrupt. If there are more priority channels than the value you select, the channels are divided into more than one group and the scanner scans each group in turn.

Example: If you set the maximum channels to 20 and there are 100 priority channels, the scanner checks those 100 channels in groups of 20 and takes a total of 5 intervals to complete the priority scan.

1-100

SCANNING BY ASSIGNING QUICK KEYS

With previous scanners, you selected banks to scan. With this scanner, you select Favorites List, Systems, and Departments to scan by assigning Quick Keys to them.

See also Understanding Quick Keys.

Scanning is performed with a mixture of FLQK, SQK, and DQK order. The scanner will not scan all Systems in one Favorites List and then move to the next List.

For each Favorites List, starting with 0, the scanner will scan each 0 SQK in FLQK order and then move to the next set of SQKs for each list.

Example:

FLQK 0, SQK 0; FLQK 1, SQK 0... FLQK 98, SQK 99; FLQK 99, SQK, 99.

Systems with the same quick key are scanned in order of creation.

The Database is scanned next, in order of creation. Then, Systems with no quick key (including created Quick Save Systems) are scanned and in order of creation.

Departments within Systems are also scanned the same as Systems.

Conventional Channels within Systems are also scanned in order of creation.

IDs are not really scanned. The scanner checks for any activity in the trunking system and:

- Will display all IDs when ID Search mode is set to On.
- Will display only programmed IDs when ID Search mode is set to Off.

Next, any Custom Searches (enabled for Search with Scan) are scanned in order.

Then, the scanner scans the Close Call 'Hits with Scan' system (if Unavoided). This is a system that automatically stores the frequencies found by Close Call. If the 'Hits with Scan' system has no frequencies, the scanner will not scan the system.

The scanner scans a system for the duration you set using the System Hold Time option. For trunked systems, the scanner moves to the next system after the hold time expires, the current transmission ends, and the channel delay expires. Conventional systems operate similarly, but all (Unavoided) channels are scanned at least one time regardless of the hold time setting.

Scanning Checklist:

1. You must enable at least one Favorites List or the Full Database in Select Lists to Monitor.
2. Favorites Lists, Systems, or Departments with Quick Keys assigned to them must be enabled with quick keys or through Manage Quick Key Status for Favorites Lists or Systems.
3. Service Types required for channels must be set to On.

Any Favorites List not assigned to a quick key, not Avoided, and set to On in Select – to Monitor will be scanned.

Any Departments not assigned to a quick key and not Avoided will be scanned.

Any System not assigned to a quick key and not Avoided, will be scanned.

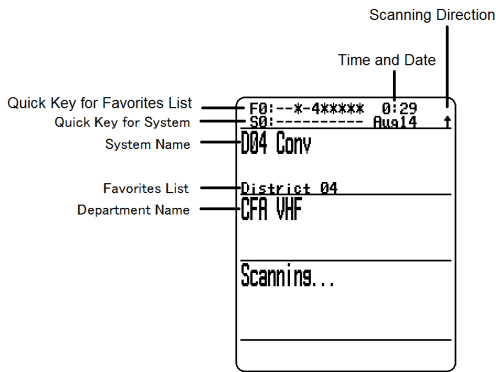

Scan Mode

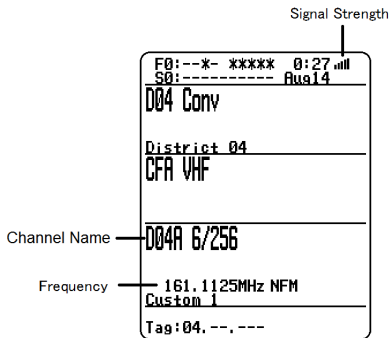

Scan Receive

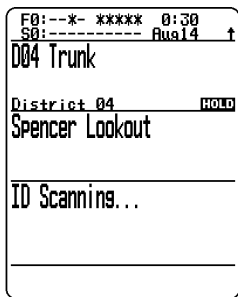

System Hold

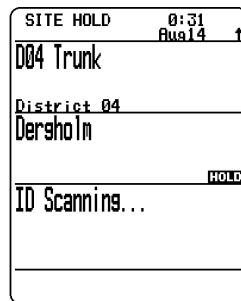

Site Hold



Trunked System - Channel Hold

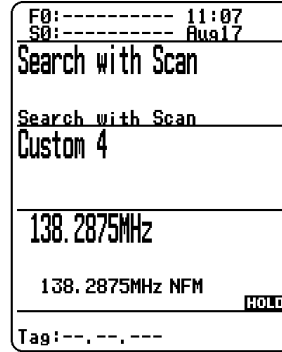

Search with Scan - Frequency Hold

Change Direction or Resume Scan Turn the Scroll Control.

SELECTING QUICK KEYS

Select a Favorites List Quick Key – Press the number key(s) assigned to the Favorites List then press E/yes. Example: 00, **E/yes** to enable or disable List 0.

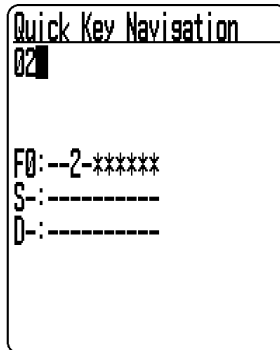

Select a System Quick Key in the Current List – Press **.no**, then the number key (2 digits) assigned to the System.

Example: **.no, 03, E/yes** to enable or disable System 3.

Select a Department Quick Key in the current List – Press **.no** twice, then the number key (2 digits) assigned to the Department.

Example: **.no** twice, **07, E/yes** to enable or disable Department 7.

Select a System Quick Key in a Different List – Press the number key(s) assigned to the Favorites List then **.no**, then the number key (2 digits) assigned to the System then **E/yes**.

Example: 00, **.no, 04, E/yes** to enable or disable List 0, System 4.

TOGGLE DISPLAY MODES

Hold on any channel and press **Func** then **9(DISP)**. Press **Channel** to resume.
You can turn on Disp. Unit ID on and off.

TOGGLE ID SCAN OR ID SEARCH

While scanning each Trunked System, press **Func** then **E/yes**.

SELECT SERVICE TYPES

Press **Func** then **List/Services**.
Scroll to each Service Type and press **E/yes** to enable or disable.

HOLDING

Channel Hold

Press **Channel** to hold on a Channel. Scroll to channels.
Press **Channel** to release Hold mode.

Department Hold

Press **Dept** to pause then hold on any Department.
Double press **Dept** to hold without a pause.
Press **Dept** then quickly scroll to the **Department** in pause mode.
Double press **Dept** to release Department hold.

Site Hold

Press **Func** then **Dept** to hold on any Site.
Press **Func** then **Dept** to release Site hold.
Press **Dept** then rotate the scroll control to select a Site.

System Hold

Press **System** to pause then hold on any System.
Double press **System** to hold without a pause.
Press **System** then quickly scroll to the **System** in pause mode.
Double press **System** to release **System** hold.

REPLAY THE LAST TRANSMISSIONS

While scanning, press **Replay**.
Press **Channel** to pause/resume replay.
Turn the **Scroll Control** to select recordings.

START/STOP RECORDING

While scanning, press **Func** then **Replay**.
Note: Resets to Off when you turn off the scanner.

ADVANCED CHANNEL MENU

While the channel is in the display, press **E/yes**.
Edit Current Channel - See Channel Options.
Add to Favorites List - Press **E/yes** or **./no**.

- At **Select Favorites List**, scroll to the Favorites List and press **E/yes**.
- Save Sub Audio/P25 NAC** - CTCSS Tone or DCS/NAC Code (blinking)
 - At **Are you sure?**, press **E/yes**.
- Save Talk Group ID** - Unknown Talk Group ID with ID Search
 - At **Are you sure?**, press **E/yes** or **.No**.
- At **Select Department**, scroll to the Department and press **E/yes**.
- Save Unit ID** - Unknown Unit ID
 - At **Are you sure?**, press **E/yes** or **.No**.

STORE A SEARCH FREQUENCY (SEARCH WITH SCAN)

Press **E/yes**.

Then see Storing Frequencies.

Adding Systems From the Database

Press **E/yes** to store a frequency.

ATTENUATION

Channel Attenuation - Press **Channel** to hold on the channel and press **Func** then **4(<ATT)** to toggle attenuation.

Global Attenuation - Press **Channel** to hold on any channel then press **Func** then press and hold **4(<ATT)** to toggle global attenuation.

MODULATION

Conventional Channel Modulation

Press **Channel** to hold on the channel.

Press **Func** then **Channel(MOD)** to toggle modulation.

Press **Channel** to release hold mode.

Site Modulation

Press **Func** then **Dept** to hold on the Site.

Press **Channel** to hold on any channel.

Press **Func** then **Channel(MOD)** to toggle modulation.

Press **Channel** to release hold mode.

Press **Func** then **Dept** to release Site hold mode.

INTERMEDIATE FREQUENCY EXCHANGE

Press **Channel** to hold on the channel.

Press **Func** then **7(IFX)** to toggle on or off.

REPEATER FREQUENCY CONVENTIONAL CHANNEL

Press **Channel** to hold on the channel.

Press **Func** then press and hold **8(REV)**.

CHANNEL VOLUME OFFSET

Press **Channel** to hold on the channel.

Press **Func** then press **0(LVL)** to toggle.

AVOIDING CHANNELS, DEPARTMENTS, SITES, AND SYSTEMS

Avoids are common to every System in the Favorites List.

Temporary Avoids cancel when you cycle power. See also Review Avoids.

Channel Avoid When the Channel is in the display or in Channel Hold mode:

To **Temporary Avoid**, press **Avoid** once.

To **Permanent Avoid**, press twice when the channel is in the display or in Channel Hold mode.

Department Avoid

Press **Dept** then **Avoid** once to **Temporary Avoid**.

Press **Avoid** twice to **Permanent Avoid**.

Site Avoid When the Site is in the display or in Site Hold mode (Func then Dept):

To **Temporary Avoid**, press **Dept** then quickly press **Avoid**.

To **Permanent Avoid**, press **Dept** then quickly press **Avoid** twice.

To **Stop Avoiding**, press **Dept** then **Avoid** once.

Press **Func then Dept** to release Site hold.

System Avoid

Press **System** then **Avoid** once to **Temporary Avoid**.

Press **Avoid** twice to **Permanent Avoid**.

SET THE RANGE

See Set Range.

See also Understanding Range and Understanding Location Control.

DIRECT FREQUENCY/TGID ENTRY

Press **Channel** to hold on any Channel.

Enter the Frequency/TGID and press **E/yes**. Press **Channel** to release hold.

USING NUMBER TAGS

If two Favorites Lists have the same number tag, they will be selected in sequence. The first time you select the number tag, the scanner will go to the first Favorites List assigned to that number tag; if you select the same number tag again, it will go to the 2nd Favorites List assigned to that number tag, and so on. The same rule applies to System and Channel number tags.

View Number Tags

Number Tag is always displayed in Scan Hold mode.

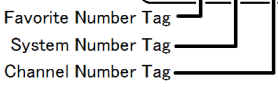

Go To Number Tag

Press **Channel** to hold on any channel.
 Enter the Favorites number tag, **.no**, then the System number tag, **.no**, then the Channel number tag and press **Channel**.

Examples:

1.01.36 to go to Channel 36 in System 01 in Favorites List 1.

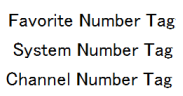
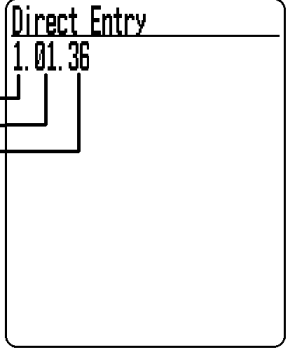

.01.36 to go to Channel 36 in System 01 in current Favorites List.
..36 to go to Channel 36 in current System.

CLOSE CALL MODES

To toggle **CC Off**, **CC DND**, or **CC Pri**:
 Hold on any channel and press **Func** then **Avoid** ().

Close Call Hit

See Using Close Call.

PRIORITY MODES

Press **Func** then **.no(PRI)** to toggle Priority mode Off, DND, or On.

CUSTOM SEARCH BY SEARCH KEY

Press **Channel** to hold on any channel.

Press **Func** then 1(SRCH1), 2(SRCH2), or 3(SRCH3), to start a Custom Search assigned to a Search Key.

CLOSE CALL ONLY

Press **Func** then press and hold **Avoid** ().

TONE-OUT STANDBY/SEARCH

Assign Tone-Out Standby/Search to a Search Key.

REVIEW AVOIDS

Database Avoids. Press **Menu** and scroll to **Manage Full Database**.

Scroll to the following:

Review Avoids - Scroll to each channel, department, site, or system and press **E/yes** to **Stop Avoiding**. Temporary Avoids appear reversed in the display - **AVOID** .

Stop All Avoiding - At **Confirm?**, press **E/yes** or **.no**.

Favorites List Avoids. Press **Menu** and scroll to **Manage Favorites**.

Scroll to the **Favorites List** and press **E/yes**.

Scroll to the following:

Review Avoids - Scroll to each channel, department, site, or system and press **E/yes** to **Stop Avoiding**. Temporary Avoids appear reversed in the display - **AVOID** .

Stop All Avoiding - At **Confirm?** press **E/yes** or **.no**.

ID Avoids. Press **Menu** and scroll to **Manage Favorites**.

Scroll to the **Favorites List** and press **E/yes**.

Scroll to **Review/Edit System** and press **E/yes**.

Scroll to the **System** and press **E/yes**.

Scroll to **Edit Sys Options** and press **E/yes**.

Scroll to the following:

Review ID Avoids - Scroll to each ID and press **E/yes** to Stop Avoiding.

Clear All ID Avoids - At **Confirm?** press **E/yes** or **.no**.

Clear All Avoids for Site or Department – Press **Channel** to hold on any System. Press and hold **Avoid**.

QUICK SEARCH

Press **Func** then **E/yes** to start Quick Search at the current frequency.

DIGITAL ADJUSTMENT MODE

Press Scroll Control knob then **Func** then Scroll Control knob. Press Scroll Control knob to exit.

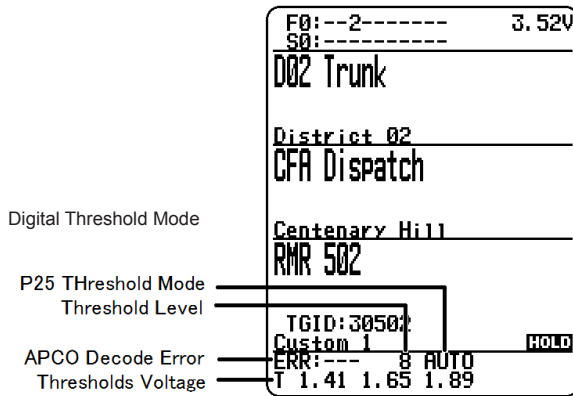

Set the Digital Threshold mode to **Manual** in Site Options or System Options for a Conventional channel.

Press **Func** then **Dept** to hold on a Site or **Channel** to hold on a digital Channel.

The first line on the display now shows the digital error rate and the decode threshold setting (0-20). The second line on the display shows the decode threshold levels for the site.

Allow the scanner to monitor the site or channel for several minutes. The error rate should drop for each transmission and the threshold levels should automatically adjust to a more optimal setting. Then, once the threshold level settles to a stable setting, make a note of the value. This is the site's or channel's optimum decode threshold.

Press **Func** and rotate the **Scroll Control** to set the **MAN** decode threshold start level to a setting that most closely matches the system's optimum decode threshold. Whatever you set at this point will be remembered for this site as the starting point for the auto-tuning function for subsequent transmission on site. See also Digital Threshold Level.

USING A GPS

LOCATION-BASED SCANNING

You can connect the scanner to a compatible GPS device and set the scanner to automatically Avoid and Unavoid Departments and Sites based on your current location. This frees you from having to manually enable and disable Departments and Sites as you change locations.

Use the 4-pin mini plug to connect to the scanner using a NMEA compatible GPS device.

A good application of this feature would be to set the longitude and latitude for each multi-site system transmitter as usually you can receive at least a handful in any given location. Set the range to around 48 kilometers and the scanner will automatically Avoid or Unavoid Sites when

in and out of range. It may also be relevant to set different locations/ranges for the Departments within the site.

You can find the physical location of antennas using the databases available at Radio Reference or the FCCs Antenna Structure Registration site.

Both sites list the latitude, longitude, and height of the antenna and both sites can map the exact location for you.

Once the scanner completes the initial GPS review, if you move into or out of an area covered by a Site/Department, the scanner will Avoid and Unavoid Sites and Departments according to Range settings for the scanner and Sites/Departments.

If you cycle power, all Sites/Departments are Unavoided until the scanner reacquires the GPS signal and completes the initial GPS review.

Note: If you unplug your GPS device or it loses reception to satellites, the scanner will use the last known location as the current location.

See also Set Location to set your Location, Range, and relevant GPS options.

See also Understanding Location Control and Understanding Range.

All Sites/Departments with locations set and not within range of your current location will be temporarily Avoided.

DISCOVERY MODE

Trunking Discovery mode allows you to monitor a trunked radio system, logging system channel activity and recording the audio for channels.

Conventional Discovery mode lets you monitor a range of frequencies, logging frequencies with activity and recording the audio for frequencies that are not already known to be in use in your area so that you can more easily identify the users. This includes frequencies used conventionally as well as in trunked radio systems.

In both modes, you also have the option to compare hits to the Database and log all hits or just new hits.

If you use the **Auto Store** option, Discovery will create a new Trunking System for IDs found for each Session or will create a new Conventional System for frequencies found for each Session.

You can create and save several sessions with different settings. Every time you start a session you create a Run that can later be reviewed in the scanner or the Sentinel software.

NEW SESSION

Press **Menu** then scroll to **Discovery** and press **E/yes**.

Scroll to Trunking Discovery or Conventional Discovery and press **E/yes**.

Scroll to New Session and press **E/yes**.

Conventional Discovery

Input Session Name - Enter the **Name** and press **E/yes**. See Data Naming.

Trunking Discovery

Input System Name - Enter the first few relevant letters of the system and press **E/yes**. See Data Naming.

Note: The System must be enabled for scan to input system name.

Select System - Scroll to the **System** and press **E/yes**.

Select Site - Scroll to the **Site** and press **E/yes**.

Input Session Name - Enter the Name and press **E/yes**. See Data Naming.

SESSION OPTIONS

Press **Menu** then scroll to **Discovery** and press **E/yes**.

Scroll to **Trunking/Conventional Discovery** and press **E/yes**.

Scroll to the **Discovery Session** and press **E/yes**.

Start Discovery	Set Compare to database
Edit Session Name	Set Record Duration
Set Limit Frequencies	Set Time-Out Timer
Set Modulation	System Information
Set Step	Set Auto Store
Set Delay	Delete Session
Set Logging	Change System

Start Discovery

This starts the Discovery Session.

Press **Menu** to stop and review the Run information. See Review Discovery.

Press **Avoid** to Avoid a hit.

Press **Func** then **System** to exit.

Edit Session Name

This allows you to name a Session.

See Data Naming.

Set Limit Frequencies (Conventional Only)

This sets the lower and upper frequencies for conventional discovery session.

Set Lower Limit Enter the lower limit.

Set Upper Limit Enter the upper limit.

Set Modulation (Conventional Only)

This sets the modulation for conventional discovery session.

Auto, AM, FM, NFM, WFM, or FMB (FM Broadcast)

Set Step (Conventional Only)

This sets the step size for conventional discovery session.

Auto, 5, 6.25, 7.5, 8.33, 10, 12.5, 15, 20, 25, 50, or 100 kHz

Set Delay

This sets the Delay when monitoring a site or frequencies.

0, 1, 2, 3, 4, or 5 sec.

Set Logging

This will log all hits or just new hits.

All or New Only

Set Compare to Database

Select On to compare hits against the channels already in the Database. Only new channels will have audio recorded (if enabled). Select Off to treat all hits as new channels.

On or Off

Set Record Duration

This sets how much audio will be recorded for each new channel.

None, 30, 60, 90, 120, 150, 180, 300, or 600 sec.

Set Time-Out Timer

This is used to keep a stuck channel from stealing the whole Run in a session.

Off, 10, 30, or 60 sec.

System Information (Trunking Only)

This will give you where it came from, (Full Database or Favorites List), the System Type, (Motorola, P25, etc.), and the System used for the Discovery Session.

Set Auto Store

This turns Auto Store on and will create a System called **Conventional** or **Trunking Discovery**.

On or Off

Delete Session

This deletes the session.

At **Confirm Delete?** Press **E/yes** or **./no**.

Change System (Trunking Only)

This allows you to create or change the System used and change the Site used for the session.

Input System Name

Press **E/yes** to **Skip** if System is saved.

See Data Naming.

Select System

Select the **System** to use for the session.

Select Site

Select the **Site** to use for the session.

REVIEW DISCOVERY

In Review Discovery mode, you can review the results of discovery mode runs, resume runs, or restart saved discovery sessions.

Press **Menu** then scroll to **Discovery** and press **E/yes**.

Scroll to **Review Discovery** and press **E/yes**.

Scroll to **Trunking/Conventional Discovery Results** and press **E/yes**.

Scroll to select each **Run**.

Review Run Results

Summary List by each frequency.
 Detail - List by each hit.
Restart this Run. Delete all log files.
Restart? Press **E/yes** or **./no**.
Resume this Run Continue without deleting log files.
Resume? Press **E/yes** or **./no**.
Delete this Run
 At **Confirm Delete?**, press **E/yes** or **./no**.
Rename this Run
 See Data Naming.
Run Information
 Shows the Session settings.

SEARCH/CLOSE CALL OPTIONS

These are the settings you should look at before you perform a Quick Search, or Close Call Search.

Press **Menu**. Scroll to **Srch/CloCall Opt** and press **E/yes**.

Scroll to the options below and press **E/yes**.

Freq Avoids	Set Delay Time	Digital Waiting Time
Broadcast Screen	Set Attenuator	Digital Threshold Mode
Repeater Find	Set Audio AGC	Digital Threshold Level

Freq Avoids – This allows you to review Avoided Frequencies or Stop Avoiding all Frequencies for Searching and Close Call search.

Temporary Avoids appear reversed in the display - **AVOID**.

Stop All Avoiding. See also Search Avoids.

At **Confirm?** Press **E/yes** or **./no**.

Rvw Search Avoid

Scroll to Frequency and press **E/yes** to Stop Avoiding.

Broadcast Screen – Automatically ignores transmissions that are on common broadcasts, paging systems, and other annoyance radio sources during Custom Search, Quick Search, or Close Call Search. The default setting is **Pager On**.

Set All Band On/Off. Turns Broadcast Screen **On** or **Off** for All Bands.

Set Each Band

Scroll to each **Band** and press **E/yes** to enable or disable.

Program Band

Band 0-9 Select for each Close Call Band and other searches.

Set Lower Limit - Input the lower frequency limit.

Set Upper Limit - Input the upper frequency limit.

Press **Menu** to return and repeat for each band as needed.

Repeater Find – Sets whether the scanner tries to tune to a repeater output frequency when it detects a transmission on a repeater input frequency, in Search and Close Call modes. Turning this feature on can let you hear both sides of the conversation on the output frequency. The default setting is **Off**.

On or Off

Set Delay Time – Determines how long the scanner waits after a transmission ends before resuming Quick Search and Close Call Search operations.

A negative delay will force a resume after that number of seconds.

The default setting is **2** seconds.

-10, -5, 0, 1, 2, 3, 4, 5, 10, or 30 sec.

Set Attenuator – This controls the attenuator for Quick Search, and Close Call operations by about 20dB. The default setting is **Off**.

On or Off

See also Search Attenuation.

Set Audio AGC – This allows you to turn AGC (Automatic Gain Control) on or off for Quick Search and Close Call modes. The default settings are **Off**.

Analog. Press **E/yes** to toggle **On** or **Off**.

Digital. Press **E/yes** to toggle **On** or **Off**.

Digital Waiting Time – This setting gives the scanner time to determine if frequencies have digital or analog transmissions. During this time, the scanner will evaluate the received signal and, if it detects digital data, will open squelch immediately. If digital is not detected before the delay expires, the scanner will open squelch at the end of this delay. This is to prevent “false decode” problems. The default setting is **400** ms.

0 to 1000 ms

Note: *Any analog transmissions will lose the first part of the transmission, up to the wait time you set here.*

Digital Threshold Mode – The default setting is **Auto**.

Auto. Automatically sets the decode threshold based on the received signal.

Manual. Allows you to manually set the threshold in threshold setting mode or using the Digital Threshold Level setting.

Default. Sets the scanner to the default threshold of **8, Auto**.

Digital Threshold Level – The default setting is **8**.

5 to 13

SEARCH OPTIONS

Press **Menu**. Scroll to Search for... and press **E/yes**.

Scroll to the options below and press **E/yes**.

Custom Search

Set Search Key

Edit Custom

Search with Scan

IMPORTANT! *There are many options and setting in Search/Close Call Options that affect and compliment the settings for searching. Please review those first.*

EDIT CUSTOM

You can edit the 10 Custom Search ranges. The default custom search range names appear as **Custom 1**, **Custom 2**, and so on.

Custom 0-9. Select for each Custom Search.

Edit Name. See Data Naming.

Edit Srch Limit

Set Lower Limit. Enter the lower limit.

Set Upper Limit. Enter the upper limit.

Set Delay Time

-10, -5, 0, 1, 2, 3, 4, 5, 10, or 30 sec.

Set Modulation

Auto, AM, NFM, FM, WFM, or FMB (Broadcast)

Set Attenuator

On or Off

Set Step

Auto, 5, 6.25, 7.5, 8.33, 10, 12.5, 15, 20, 25, 50, or 100 kHz

Set Audio AGC

Analog - Press **E/yes** to toggle **On** or **Off**.

Digital - Press **E/yes** to toggle **On** or **Off**.

Digital Waiting Time

0 to 1000 ms

Digital Threshold Mode

Auto, Manual, Default

Digital Threshold Level

5 to 13

Search with Scan. See also Select Lists to Monitor and Search with Scan.

Set Avoid

Stop Avoiding, Temporary Avoid, or Permanent Avoid

Set Hold Time. Sets how long to search when scanning.

Enter the hold time (0-255 sec.) and press **E/yes** to save.

SET SEARCH KEY

The scanner has three search keys that you can assign to a search range. The search keys are number keys **1**, **2**, and **3**. This allows you to start a Custom, Tone-Out, or Close Call Search without having to go into the menus.

Search Key 1-3. Select a search for each Search Key.

. (nothing assigned), Custom Search 0-9, Tone-Out, or Close Call.

SEARCH WITH SCAN

This enables Custom Searches in Scan mode.

See also Select Lists to Monitor and Edit Custom Search.

Set System Avoid

Stop Avoiding, Temporary, or Permanent Avoid.

QUICK SEARCH

Allows you to start searching at the displayed frequency, or enter a frequency and start searching from that frequency in hold modes.

Quick Search will search all the way up to 1300 MHz or all the way down to 25 MHz then start over.

To Start a Quick Search from the Displayed Frequency:

Press **Channel** to hold on the channel or frequency.

Press **Func** then **E/yes**. At Quick Search? Press **E/yes**.

Press **Channel** again to release hold mode and start searching.

To Start a Quick Search from a New Frequency:

Press **Channel** to hold on any channel or frequency.

Enter the new frequency then press **Channel** to set the new starting frequency. Press **Channel** again to release hold mode and start searching.

Press **Channel** to hold on any channel or frequency. Enter the new frequency you wish to start at then press **Channel** to set the new starting frequency. Press **Channel** again to release hold mode and start searching.

CUSTOM SEARCH

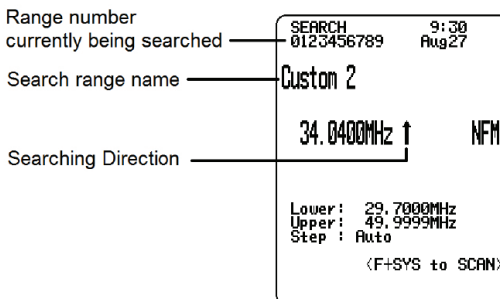

Allows you to search the scanner's 10 programmed frequency ranges.

See also Edit Custom Search.

Press **Menu**. Scroll to **Search for...** and press **E/yes**.

Scroll to **Custom Search** and press **E/yes**.

See also Set Search Key.

Change Direction or Resume Search

Turn the Scroll Control.

Select Custom Search Bands

Press the number keys to enable or disable each Custom Search band.

Holding

Frequency Hold. Press **Channel** to hold on a Frequency.

Scroll to frequencies. Press **Channel** to release hold.

Avoiding Frequencies

Temporary Avoids cancel when you cycle power.

Frequency Avoid - Press **Avoid** once to **Temporary Avoid**.

Press quickly to toggle **Permanent Avoid** and **Stop Avoiding** when the the scanner stays in a frequency or in Search Hold mode.

Review Avoids - Press **Channel** to hold on any Frequency.

Press **Func** then **Avoid**. Scroll to each frequency and press **E/yes** to **Stop Avoiding**. Temporary Avoids appear reversed - **AV** .

Stop All Avoiding - Press **Channel** to hold on any Frequency.

Press and hold **Avoid**. The scanner displays Search Frequencies All Unavoided.

See also Freq Avoids.

Attenuation

Band Attenuation. Press **Func** then **4(<ATT)** for each band.

Global Attenuation. Press **Channel** to hold on any frequency then press and hold **Func** then **4(<ATT)** to toggle global attenuation.

Modulation

Press **Func** then **Channel(MOD)** for each band.

Direct Frequency Entry

Press **Channel** to hold on any frequency. Enter the frequency and press **Channel**. Press **Channel** to release hold.

Frequency Intermediate Exchange

Press **Channel** to hold on any frequency. Press **Func** then **7(IFX)** to toggle on or off.

Repeater Frequency

Press **Channel** to hold on any frequency.

Press **Func** then press and hold **8(REV)**.

Replay the Last Transmissions

While searching, press **Replay**.

Press **Channel** to pause/resume replay.

Turn the **Scroll Control** to select recordings.

Start/Stop Recording

While searching, press **Func** then **Replay**.

Note: Resets to Off when you turn off the scanner.

Storing Frequencies

Displayed Frequency into a Quick Save Department – Press **E/yes**.

You will see **Quick Frequency Save** in the display then press **E/yes**.

The scanner stores the frequency into the Quick Save Department in the Quick Save System.

Displayed Frequency into an Existing Department – Press **E/yes**.

You will see **Saving to Quick Dept** in the display then press **.no**.

At **Saving Channel** to scroll to the Favorites List and press **E/yes**.

At **Select System** scroll to the System and press **E/yes**.

At **Select Department** scroll to the and press **E/yes**.

After storing the frequency, you will be at the Edit Channel menu to complete the settings for the new channel.

If you don't want to edit the channel settings or are done editing the channel, press **Avoid** to return to searching.

Search Menu

Press **Func** then **Menu**.

Close Call Modes

To toggle **CC Off**, **CC Pri**, or **CC DND**:

Press **Func** then **Avoid** ().

CLOSE CALL

Your scanner's Close Call feature lets you set the scanner so it detects, alerts you to, and displays the frequency of a nearby strong radio transmission. You can set the scanner so the Close Call feature checks for a Close Call hit every 2 seconds in the background while you are scanning, searching, listening to the weather frequency, etc. or use Close Call Only mode. Close Call 'Do-Not-Disturb' will only check for close call signals when you are not receiving transmissions. You can also select the frequency band(s) to look for transmissions. When the scanner detects a Close Call hit, it alerts you according to the alert settings.

'Hits with Scan' is a special system that automatically stores the last 10 Close Call hits until you cycle power.

The Close Call feature works well for locating the source of strong local transmissions such as mobile and handheld two-way radios in areas with no other strong transmission sources. Performance is increased with higher transmit power, a receive antenna tuned to the target band, and a low background RF level.

The Close Call feature works better with some types of transmissions than others.

It might not correctly display frequency information for transmitters using a highly directional antenna (such as an amateur radio beam antenna) or if there are many transmitters operating at the same time in the same area.

CLOSE CALL OPTIONS

Important! There are many options and settings in Search/Close Call Options that affect and compliment the settings for Close Call. Please review those first.

Note: *Close Call does not operate in Weather Scan or Tone-Out Standby/Search.*

Press **Menu**. Scroll to **Close Call** and press **E/yes**.

Scroll to the options below and press **E/yes**.

Close Call Only	Set CC Bands
Hits with Scan	Set CC Alert
Set CC Mode	

Close Call Only

This setting puts the scanner in Close Call Only mode.

See also Using Close Call.

You can also toggle these modes by:

Holding on any channel and pressing **Func** then **Avoid** ().

Hits with Scan

This is a special system that automatically stores the last 10 close call hits and allows you to scan them. Accessible only in the Close Call menu, the system has to be Unavoided to view while scanning (default is Permanent Avoid). The scanner will delete the frequencies in this system when you turn the power off.

Set Avoid

Stop Avoiding, Temporary, or Permanent Avoid

Set Hold Time. Sets how long to search when scanning.

Enter the hold time (0-255 sec.) and press **E/yes** to save.

Set CC Mode

Selects the Close Call mode when scanning or searching.

Off. Close Call is turned off.

CC DND. Close Call checks for frequencies every two seconds when the scanner is not receiving a transmission.

CC Priority. Close Call checks for frequencies every two seconds.

You can also toggle these modes by:

Holding on any channel and pressing **Func** then **Avoid** ().

Set CC Bands

Lets you select the Close Call bands to be searched.

Scroll to each **Band** and press **E/yes** to toggle **On** or **Off**.

Press **Menu** to return.

VHF Low 1 - 25-54 MHz	VHF High2 - 225-320 MHz
VHF Low 2 - 54-108 MHz	UHF - 320-512 MHz

Air Band - 108-137 MHz

800MHz+ - 806-960, 1240-1300 MHz

VHF High1 - 137-225 MHz

(Cellular frequencies not scanned)

Set CC Alert

This allows you to set an Alert Tone, Alert Light, and sets the Pause time for Close Call when you receive a hit.

Set Alert Tone

Alert 1-9 or Off.

Set Level

Level 1-15 or Auto (the master volume level).

Set Alert Light

Set Color

Off, Blue, Red, Magenta, Green, Cyan, Yellow, or White.

Set Pattern

On, Slow Blink, or Fast Blink.

Set CC Pause

3, 5, 10, 15, 30, 45, 60, sec. or Infinite.

Close Call Only Mode

Press **Channel** to hold on any channel/frequency.

Press **Func** then press and hold **Avoid** (). See also Set Search Key.

You will see activity on the 7 bands in the display. Bands with an * (asterisk) under them are turned off.

When the scanner detects a Close Call signal, **CC Found!** and **Press Any Key** display for the length of time set in Close Call Pause.

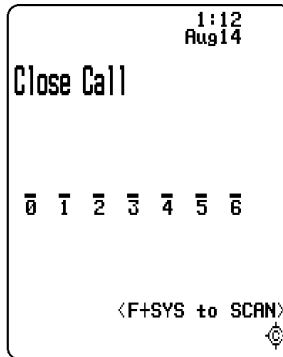

Toggle Close Call Bands

Press the number keys to enable or disable each Close Call band.

Cancel a Hit

Turn the **Scroll Control**.

Holding on a Hit

Press **System**, **Department**, or **Channel** to hold on the Close Call Hit.

Press **Channel** to cancel hold. Turn the **Scroll Control** to start **Quick Search**.

View Last Hit

Press **System**, **Department**, or **Channel** to recall the last hit.

Press **Channel** to cancel hold.

Avoiding Hits

Temporary Avoids cancel when you cycle power.

Press **Avoid** once to **Temporary Avoid**.

Press quickly to toggle **Permanent Avoid** and **Stop Avoiding** when the frequency is in the display or in Search Hold mode.

Review Avoids. Press **Channel** to hold on any Frequency.

Press **Func** then **Avoid**. Scroll to each frequency and press **E/yes** to **Stop Avoiding**.

Temporary Avoids appear reversed in the display - **T**.

Clear All Avoids - Press **Channel** to hold on any Frequency.

Press and hold **Avoid**. The scanner displays Search Frequencies All Unavoided.

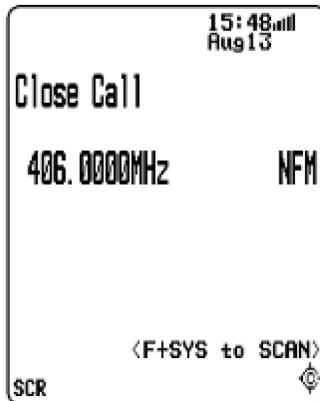

Attenuation

Press **Func** then 4(<ATT) for all bands.

Modulation

Press **Func** then **Channel(MOD)** for all bands.

Intermediate Frequency Exchange

Press **Channel** to hold on any frequency.

Press **Func** then 7(IFX) to toggle on or off.

Repeater Frequency

Press **Channel** to hold on any frequency.

Press **Func** then press and hold 8(REV).

Replay the Last Transmissions

Press **Replay**.

Press **Channel** to pause/resume replay.

Turn the **Scroll Control** to select recordings.

Start/Stop Recording

Press **Func** then **Replay**.

Note: Resets to Off when you turn off the scanner.

Storing

Displayed Frequency into a Quick Save Department. Press **E/yes**.

You will see **Saving to Quick Save Department** in the display then press **E/yes**.

The scanner stores the frequency into the **Quick Save Department**.

Displayed Frequency into an Existing Department Press **E/yes**.

You will see **Saving to Quick Save Department** in the display, then press **./no**.

At **Select Department**, scroll to the department where you want to store the frequency and press **E/yes**.

After storing the frequency, you will be at the Edit Channel menu to complete the settings for the new channel.

If you don't want to edit the channel settings or are done editing the channel, press **Avoid** to return to searching.

Close Call Menu

Press **Func** then **Menu**.

FIRE TONE-OUT

Fire Tone-Out will monitor up to 32 different channels for paging tones (two-tone sequential, single tone, and group tone).

Tone-Out Standby Mode is used if you use programmed tones.

Tone-Out Search Mode is used if you don't know the tones.

All tone-outs (channels) that have the same frequency (and modulation and attenuation) as the one you select will also (and only) be monitored so you can monitor up to 32 tone-out channels for one frequency.

In this case, the scanner displays each tone-out channel for two seconds. It does not scan them; tone-out monitors the frequency for all tone-out channels with the same frequency.

Regardless of the current display, the scanner will alert on any received tone out that matches a stored setting (channel) for the frequency.

Note: Tone-Out Search Mode will not display each Tone-Out channel for two seconds, even when multiple channels have the same frequency, modulation and attenuator settings with other channels.

TONE-OUT SETUP

Press **Menu**. Scroll to **Tone-Out for...** and press **E/yes**.

Scroll to **Tone-Out Setup** and press **E/yes**.

Scroll to **Tone-Out (0-31)** and press **E/yes**.

Note: Close Call DND/Pri and Weather Alert Priority do not operate in this mode.

Edit Name	Start Delay Time
Set Frequency	Set Alert
Set Tone	Set Audio AGC

Edit Name

See Data Naming.

Set Frequency

Edit Frequency Enter the frequency and press **E/yes**.

Set Modulation

Auto, NFM, FM

Set Attenuator

On or Off

Set Tone

Edit Tone A and press **E/yes**. Enter the tone and press **E/yes** to save.

Edit Tone B and press **E/yes**. Enter the tone and press **E/yes** to save.

Press **Menu** to return.

For two-tone pages, enter the tones (in Hz) for tone A and tone B.

For one-tone pages using short tones between 1.25 and 3.75 seconds, enter tone for tone A, and 0 for tone B.

For **long-tone pages**, such as group pages of more than 3.75 seconds, enter 0 for tone A, and the **tone** for B.

To search for tones, leave the tones for A and B at 0.

Set Delay Time

0 - the scanner resumes standby as soon as the carrier drops after a page.

1, 2, 3, 4, 5, 10, 30 - (seconds): the scanner resumes standby mode after the carrier drops and the selected time expires.

Infinite - you must press **Hold** after a page to resume standby mode.

Set Alert

Set Alert Tone

Alert 1-9 or Off.

Set Level

Level 1-15 or Auto (the master volume level).

Set Alert Light

Set Color

Off, Blue, Red, Magenta, Green, Cyan, Yellow, or White.

Set Pattern

On, Slow Blink, or Fast Blink.

Set Audio AGC

This allows you to turn AGC (Automatic Gain Control) on or off for Tone-Out operations. The default setting is **Off**.

Analog - Press **E/yes** to toggle **On** or **Off**.

FIRE TONE-OUT STANDBY/SEARCH

Press **Menu**. Scroll to **Tone-Out for...** and press **E/yes**.

Scroll to **Tone-Out Standby** and press **E/yes**.

See also Set Search Key.

Scroll to monitor a Tone-Out channel (**0-31**).

Press **Func** then **System** to exit.

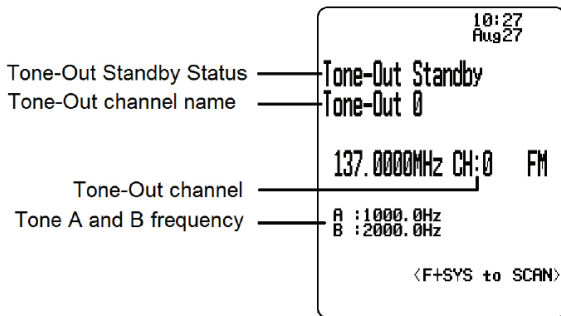

Tone-Out Standby Mode

Any transmission received on the frequency will not be heard but you will still see the signal strength bars.

To monitor a different frequency, scroll to a tone-out (channel) with a different frequency.

If you press **Channel** while in Standby/Search mode, the scanner temporarily exits and you will be able to hear any transmissions on that frequency. No alerts sound, even if a tone-out matches one you have programmed in hold mode. Press **Channel** again to return to Standby/Search mode.

If the scanner finds tones in Tone-Out Search mode, you will see **Set Found Tone A and B?** after you press **E/yes** to save.

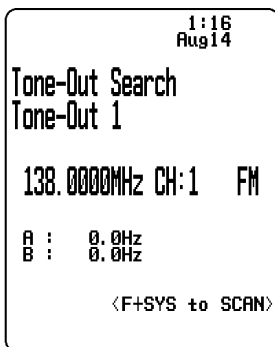

Tone-Out Search Mode

Select a Different Tone-Out

Turn the **Scroll Control**.

Listen to Tone-Out Frequency

Press **Channel**.

Attenuation

Press **Func** then **4(<ATT)**.

Modulation

Press **Func** then **Channel(MOD)**.

Intermediate Frequency Exchange

Press **Func** then **7(IFX)** to toggle on or off.

Start/Stop Recording

Press **Func** then **Replay**.

Note: Resets to Off when you turn off the scanner.

Store Found Tones

Press **E/yes** at **Save Found Tones?**.

Tone-Out Menu

Press **Func** then **Menu**.

APPENDIX

TROUBLESHOOTING

Scan Mode, Nothing to Scan

1. Make sure the Favourites Lists are enabled in Set Scan Selection
2. Make sure Service Types are enabled for the Channels you want to hear.
3. Make sure you have locations programmed if Use Location Control is On.
4. Make sure longitude and latitude are N and W.
5. Make sure Systems/Departments/Channels are not Avoided.
6. Make sure Favorites List/System/Department quick key is enabled.
7. (Search with Scan) Make sure Search with Scan is enabled in Select Lists to Monitor and the Search for Menu and for the Custom Search.

Scanning Interrupted

1. Turn off Priority Scan. Change Priority Interval.
2. Turn off Close Call Priority.
3. Set Channel Delay longer.
4. Set positive Channel Delay.

All Channels Out of Range

1. Increase your range.
2. Turn Location Control off for the Favorites List..

DEFAULT BAND COVERAGE

Frequency (MHz)		Mode	Step (kHz)
Lower	Upper		
25.0000	29.9950	FM	5
30.0000	79.9875	FM	12.5
80.0000	82.9900	FM	10
83.0000	87.2875	FM	12.5
87.3000	107.9500	FMB	50
108.0000	136.9916	AM	8.33
137.0000	137.9950	FM	5
138.0000	157.9875	FM	12.5
158.0000	160.5900	FM	10
160.6000	162.5875	FM	12.5
162.6000	173.9900	FM	10
174.0000	215.9500	WFM	50
216.0000	224.9950	FM	5

225.0000	399.9750	AM	25
400.0000	405.9875	FM	12.5
406.0000	439.9937	FM	6.25
440.0000	465.9950	FM	5
466.0000	469.9900	FM	10
470.0000	512.0000	FM	6.25
806.0000	960.0000	FM	12.5
1240.0000	1300.0000	FM	12.5

When you select **AUTO** for a channel, modulation, or step, the above values are used unless you've edited the Band Defaults

Steps can be selected from 5/6.25/7.5/8.33/10/12.5/15/20/25/50/100/AUTO (kHz).

SERVICE TYPES

Service Type	Description
Aircraft	For civilian aircraft and air traffic control operations most typically in the 118-136 MHz and 225-380 MHz bands in AM mode.
Business	Most business related entities not covered by other tags.
Corrections	Jail/prison operations, corrections activities, federal prisons.
Emergency Ops	Emergency Operation Centers and similar emergency management or disaster related operations.
EMS Dispatch	Ambulance dispatch, including rescue squads.
EMS-Tac	Ambulance on-scene communications, tactical operations and secondary channels.
EMS-Talk	Ambulance talk-around, car-to-car and supervisor operations.
Federal	All federal government operations (except corrections, traditional law enforcement patrol and fire/EMS operations).
Fire Dispatch	Fire dispatch, including combined fire/ambulance dispatch.
Fire-Tac	Fireground, tactical and on-scene communications, including combined fire/ambulance operations.
Fire-Talk	Fire talk-around and car-to-car operations, chiefs, supervisors, etc., including combined fire/ambulance operations.
Ham	Any amateur radio assignment
Hospital	Ambulance-to-Hospital communications and patient reports.
Interop	Interoperability communications, cross-agency communications, mutual aid, etc.
Law Dispatch	Law enforcement dispatch.
Law-Tac	Law enforcement tactical, SWAT, on-scene, surveillance and specific sub-agency communications.
Law Talk	Law enforcement talk-around, car-to-car and supervisor operations.
Media	Newspapers, television and broadcast radio operations.

Service Type	Description
Military	Military operations, e.g., range control, air-to-air combat, etc.
Multi-Dispatch	Combined law enforcement and fire/ambulance dispatch.
Multi-Tac	Combined law enforcement and fire/ambulance tactical and on-scene communications.
Multi-Talk	Combined law enforcement and fire/ambulance tactical talk-around and car-to-car operations.
Public Works	Public agency non-public safety communications. This includes any non-public safety government services, such as trash, streets, roads, sewer, zoos, administration, maintenance, animal control, community initiatives, code compliance, etc.
Racing Officials	Available for use to identify officials' frequencies for racing events.
Racing Teams	Available for use to identify team frequencies for racing events.
Railroad	All common carrier railroad communications.
Schools	School-related communications (schools, school buses, football games, etc.).
Security	Non-law enforcement security operations, including private security companies, noncommissioned government agency security, school security, etc.
Transportation	Public and private bus, taxi, and public passenger rail communications.
Utilities	Private electric, water, natural gas, phone, cable TV, etc. operations.
Other	Miscellaneous channels that do not fall into another service type.
Custom 1-8	User-defined service types. These can be used for custom groups of channels, systems, sites, etc.

REMOVING THE microSD CARD

Turn your scanner off. Carefully remove the microSD card by using a thumbnail or pencil eraser to push the card in so it will spring out. Handle with care if you are going to use it in a card reader. Gently install the microSD card the same way it was removed and to push the card in so it will spring back into place.

Reformatting the microSD Card

Reformat microSD cards using a special SD Card Formatter (https://www.sdcard.org/downloads/formatter_4/). Then, you need to "Clear User Data" using Sentinel to restore all HP files and directories to the card.

After formatting, the HP won't be automatically detected (since it is wiped clean), so you may need to uncheck "Hide empty drives" in windows "Tools>Folder Options>View before doing the "Clear User Data" step.

ENTERING IDS

These are the acceptable ID entry formats.

Partial IDs can be used to receive all IDs in a Fleet, Sub-Fleet, Agency, etc.

Partial IDs can also be Avoided.

System Type		TGID Format
Motorola Type 1 Systems	B = Block F = Fleet S = Sub-Fleet N = Decimal Number i = I-Call ID	BFF-SS = Normal ID BFFF-S = Normal ID (Fleet is 100 - 127) BFF- = Partial Fleet ID BFFF- = Partial Fleet ID (Fleet is 100 - 127) B- = Partial Block IDS
		NNNNN (Size code 0) iNNNNN (Size code 0)
Motorola Type 2 Systems	N = Decimal Number H = Hexadecimal Number i = I-Call ID	<i>Decimal Format</i> NNNNN iNNNNN <i>Hexadecimal Format</i> HHHH iHHHH
P25 Systems	N = Decimal Number H = Hexadecimal Number i = I-Call ID	<i>Decimal Format</i> NNNNN iNNNNNNNN <i>Hexadecimal Format</i> HHHH iHHHHHH
EDACS Systems	A = Agency F = Fleet S = Sub-Fleet N = Decimal Number i = I-Call ID Only AFS Format is allowed for direct entry except for I-Call ID.	<i>AFS Format</i> AA-FFS (Normal ID) AA-FF- (Partial Fleet ID) AA- (Partial Agency ID) <i>Decimal Format</i> NNNN iNNNNN
LTR Systems	A = Area number RR = Home Repeater Number U = Decimal Number	A-RR-UUU (Normal ID) A-RR (Partial Repeater ID)

Note: A-RR (Partial Repeater ID) cannot be used with decimal formats.

TYPE II SPECIAL STATUS BITS

Type II Motorola Smartnet systems use these status bits for special transmissions such as emergency, patches, DES/DVP scrambled transmissions, and multiselects. Motorola trunking radios directly interpret them for their special functions, thus no difference is noticed by the person with the radio. The scanner however interprets these special talk group status bits as different talk groups entirely. Below is the conversion chart for these special status bits.

TT ID + # Usage	TT ID + # Usage
ID+0 Normal Talk group	ID+8 DES/DVP Encryption talk group
ID+1 All Talk group	ID+9 DES All Talk group
ID+2 Emergency	ID+10 DES Emergency
ID+3 Talk group patch to another	ID+11 DES Talk group patch
ID+4 Emergency Patch	ID+12 DES Emergency Patch
ID+5 Emergency multi-group	ID+13 DES Emergency multi-group

TT ID + # Usage	TT ID + # Usage
ID+6 unassigned	ID+14 unassigned
ID+7 Multi-select (initiated by dispatcher)	ID+15 Multi-select DES TG

Therefore, if a user was transmitting a multi-select call on talk group 1808, the scanner would actually receive those transmissions on 1815.

Some common uses of these status bits are as follows:

When a user hits their emergency button, all conversations on the talk group revert to the emergency status talk group (ID+2) until the dispatch clears the emergency status. Therefore, if someone hit their emergency button and their radio was on talk group 16, all communications would switch to talk group 18.

A lot of Fire and EMS departments dispatch tone-outs and alarms as Multi-select communications (ID+7). Therefore, if your fire department dispatch talk group is 1616, and they do dispatch tone-outs and alarms as Multi-selects, then those communications will be on talk group 1623.

Continuous Tone Coded Squelch System (CTCSS) and Digital Coded Squelch (DCS) are two methods used to prevent interference by other radio communications. Your scanner can receive transmissions that use these codes.

CTCSS and DCS systems all use some form of coded squelch. Coded squelch involves the transmission of a special code signal along with the audio of a radio transmission. A receiver with coded squelch only activates when the received signal has the correct code. This lets many users share a single frequency, and decreases interference caused by distant transmitters on the same channel. In all major metropolitan areas of the United States, every available radio channel is assigned to more than one user.

CTCSS FREQUENCIES

The scanner can detect the following 50 CTCSS frequencies.

67.0Hz	94.8Hz	131.8Hz	171.3Hz	203.5Hz
69.3Hz	97.4Hz	136.5Hz	173.8Hz	206.5Hz
71.9Hz	100.0Hz	141.3Hz	177.3Hz	210.7Hz
74.4Hz	103.5Hz	146.2Hz	179.9Hz	218.1Hz
77.0Hz	107.2Hz	151.4Hz	183.5Hz	225.7Hz
79.7Hz	110.9Hz	156.7Hz	186.2Hz	229.1Hz
82.5Hz	114.8Hz	159.8Hz	189.9Hz	233.6Hz
85.4Hz	118.8Hz	162.2Hz	192.8Hz	241.8Hz
88.5Hz	123.0Hz	165.5Hz	196.6Hz	250.3Hz
91.5Hz	127.3Hz	167.9Hz	199.5Hz	254.1Hz

DCS CODES

The scanner can detect the following hexadecimal DCS codes.

006	031	054	116	145	205	245	266	332	411	452	506	612	703
007	032	065	122	152	212	246	271	343	412	454	516	624	712
015	036	071	125	155	214	251	274	346	413	455	523	627	723
017	043	072	131	156	223	252	306	351	423	462	526	631	731
021	047	073	132	162	225	255	311	356	431	464	532	632	732
023	050	074	134	165	226	261	315	364	432	465	546	654	734
025	051	114	141	172	243	263	325	365	445	466	565	662	743
026	053	115	143	174	244	265	331	371	446	503	606	664	754

REVERSE LIST

Base Frequency (MHz)	Offset (MHz)	Base Frequency (MHz)	Offset (MHz)
29.5200 - 29.5800	+0.1	450.0000 - 454.9875	+5
29.6200 - 29.6800	-0.1	455.0000 - 459.9875	-5
52.0100 - 52.9900	+1	460.0000 - 464.9875	+5
53.0100 - 53.9900	-1	465.0000 - 469.9875	-5
143.7500	+4.375	470.0000 - 472.9875	+3
143.9000	+4.25	473.0000 - 475.9875	-3
144.5100 - 144.8900	+0.6	476.0000 - 478.9875	+3
145.1100 - 145.4900	-0.6	479.0000 - 481.9875	-3
146.0100 - 146.3850	+0.6	482.0000 - 484.9875	+3
146.4150 - 146.5050	+1	485.0000 - 487.9875	-3
146.5950	+1	488.0000 - 490.9875	+3
146.6100 - 146.9850	-0.6	491.0000 - 493.9875	-3
147.0000 - 147.3900	+0.6	494.0000 - 496.9875	+3
147.4150 - 147.5050	-1	497.0000 - 499.9875	-3
147.5950	-1	500.0000 - 502.9875	+3
147.6000 - 147.9900	-0.6	503.0000 - 505.9875	-3
148.1250	-4.375	506.0000 - 508.9875	+3
158.1500	-4.25	509.0000 - 511.9875	-3
222.1200 - 223.3800	+1.6	758.0000 - 775.9937	+30
223.7200 - 224.9800	-1.6	788.0000 - 805.9937	-30
420.0000 - 424.9875	+5	806.0000 - 823.9875	+45
425.0000 - 429.9875	-5	851.0000 - 868.9875	-45
440.0000 - 444.9875	+5	896.0000 - 901.0000	+39

Base Frequency (MHz)	Offset (MHz)	Base Frequency (MHz)	Offset (MHz)
445.0000 - 449.9875	-5	935.0000 - 940.0000	-39

TECHNICAL SPECIFICATIONS

Band Coverage : 31 Bands

Size: 71.1 mm (W) x 36.9 mm (D) x 160.9 mm (H) (without antenna)

Weight: 348.7 g (with antenna and battery)

Operating Temperature: (-10° C) to + (+60° C)

Storage Temperature: (-30° C) to + (+70° C)

Power Requirements: 3 X AA Rechargeable Ni-MH Batteries (2300mAh) (included)
3 X AA Alkaline Batteries (not included)
DC 5.0V ±5%. Connect to PC with USB cable (included)

LCD Display: 192 X 160 Full Dot Matrix LCD with white-color backlight.

Internal Speaker: 24ohm, 0.8W Max.

Scan Rate: 85 channels/second

Search Rate: 80 steps/second (12.5kHz step)
250 steps/second (5kHz step)

Scan Delay: 2 seconds

Audio Output Power: Internal Speaker - 360mW nominal (24ohm)
Headphone (L-ch) 4mW nominal (32 ohm)

Antenna: 50 ohms (Impedance)

Sensitivity (12dB SINAD) Nominal

VHF Low 1 Band

(AM)	25.005 MHz	0.4 µV
(NFM)	40.840 MHz	0.3 µV
(NFM)	53.980 MHz	0.3 µV

VHF Low 2 Band

(WFM)	54.050 MHz	0.7 µV
(FM)	72.515 MHz	0.3 µV
(FMB)	107.100 MHz	0.6 µV

Aircraft Band

(AM)	118.800 MHz	0.4 µV
(AM)	127.175 MHz	0.4 µV
(AM)	135.500 MHz	0.4 µV

VHF High 1 Band

(NFM)	138.150 MHz	0.4 μ V
(NFM)	161.985 MHz	0.3 μ V
(NFM)	173.225 MHz	0.3 μ V
(WFM)	197.450 MHz	0.6 μ V
(NFM)	216.020 MHz	0.3 μ V

VHF High 2 Band

(AM)	225.050 MHz	0.3 μ V
(AM)	272.950 MHz	0.4 μ V
(AM)	315.050 MHz	0.4 μ V

UHF Band

(AM)	325.050 MHz	0.4 μ V
(NFM)	406.875 MHz	0.3 μ V
(NFM)	511.9125 MHz	0.3 μ V

Public Service Band

(NFM)	758.0125 MHz	0.3 μ V
(NFM)	806.000 MHz	0.3 μ V
(NFM)	857.150 MHz	0.3 μ V
(NFM)	954.9125 MHz	0.3 μ V

1200MHz Band

(NFM)	1299.925 MHz	0.4 μ V
-------	--------------	-------------

Close Call Sensitivity (No Modulation)

(NFM)	40.8400 MHz	-58 dBm
(FM)	72.5150 MHz	-65 dBm
(AM)	127.1750 MHz	-69 dBm
(NFM)	161.9850 MHz	-71 dBm
(AM)	272.9500 MHz	-71 dBm
(NFM)	406.8750 MHz	-66 dBm
(NFM)	857.1500 MHz	-64 dBm
(NFM)	1299.9250 MHz	-58 dBm

Signal Noise Ratio (nominal)

VHF Low 1 Band

(AM)	25.0050 MHz	49 dB
(NFM)	40.8400 MHz	43 dB

VHF Low 2 Band

(WFM)	54.0500 MHz	53 dB
(FM)	72.5150 MHz	47 dB

(FMB)	107.100 MHz	60 dB
Aircraft Band		
(AM)	127.1750 MHz	50 dB
VHF High 1 Band		
(NFM)	161.9850 MHz	41 dB
(NFM)	173.2250 MHz	42 dB
(WFM)	197.4500 MHz	52 dB
VHF High 2 Band		
(AM)	272.9500MHz	50 dB
UHF Band		
(AM)	325.0500 MHz	50 dB
(NFM)	406.8750 MHz	41 dB
Public Service Band		
(NFM)	758.0125 MHz	42 dB
(NFM)	857.1500 MHz	42 dB
1200 MHz Band		
(NFM)	1299.9250 MHz	41 dB

Features, specifications, and availability of optional accessories are all subject to change without notice.

DECLARATION OF CONFORMITY

Hereby, Uniden Holdings Corporation declares that the radio equipment type Uniden Bearcat UBCD3600XLT is in compliance with the Directive 2014/53/EU.

The full text of the EU declaration of conformity is available at the following internet address:

www.avera.eu/downloads

Sales and Service:

info@avera.eu

www.avera.eu