

Instructions

Model HF9V

WARNING: DO NOT INSTALL THE ANTENNA WHERE ANY PART OF IT CAN COME INTO CONTACT WITH POWER LINES IN THE EVENT OF STRUCTURAL FAILURE, DURING INSTALLATION OR IN THE COURSE OF NORMAL FLEXING AFTER INSTALLATION FOR SUCH CONTACT CAN RESULT IN DAMAGE TO PROPERTY, BODILY INJURY OR EVEN DEATH!

WARNING: IN NO CASE SHOULD THE ANTENNA BE INSTALLED WHERE STRUCTURAL FAILURE OF ANY PART OF THE ANTENNA OR ITS SUPPORTING SYSTEM CAN ENDANGER PERSONS OR PROPERTY.

CAUTION! A GROUNDED ANTENNA WILL BE AT D.C. GROUND POTENTIAL! TO AVOID THE DANGER OF SHOCK CONNECT ALL STATION EQUIPMENT TO A GOOD EARTH GROUND. IT IS ALSO RECOMMENDED THAT ALL STATION EQUIPMENT BE DISCONNECTED FROM THE POWER MAINS BEFORE CONNECTING THE FEEDLINE TO THE ANTENNA. PLEASE CONSULT THE A.R.R.L HANDBOOK OR OTHER REFERENCE MANUALS FOR ADDITIONAL SAFETY PROCEDURES WHEN WORKING WITH ELECTRICAL EQUIPMENT.

NOTE: PLEASE READ ALL INSTRUCTIONS THOROUGHLY BEFORE PROCEEDING TO ASSEMBLY.

NOTE: HIGH PERFORMANCE BUTTERNUT VERTICAL ANTENNAS REQUIRE A RADIAL SYSTEM FOR ALL INSTALLATIONS.

Butternut offers three systems for installing vertical antennas:

Model GRK Ground Radial Kit for ground mounting—160 thru 6 meter operation

Model RMK-II Roof Mounting Kit for roof mounting—80 thru 6 meter operation

Model CPK Capacitive Counterpoise Kit for compact installations below 25 ft (7.6 m) above the earth—80 thru 6 meter operation

Please refer to TECH NOTES—GROUND/RADIAL SYSTEMS, at the end of this instruction, for other mounting schemes and assistance in designing your own radial system.

REQUIRED TOOLS

Flat blade screwdriver and pliers. A 1/4", 11/32" and 3/8" nut driver will be helpful.

ASSEMBLY

Refer to the appropriate diagrams and proceed as follows:

1. Check to be sure that all parts are present.
2. Install tube w/insulator (A) per instructions packaged with mounting system or Tech Notes Ground/Radial Systems.

NOTE: A small packet of anti-seize/anti-oxide compound (Butter-It's-Not™) will be found inside tube w/insulator (A). This compound should be applied lightly to each tubing joint and to the inside of all clamps that must make good electrical contact with the tubing sections.

3. Locate tube (B) and tube (B1). Slide the insulator end of tube (B1) into the end of tube (B) with hole located 1/4 in (6.4 mm) from the end of the tube. Pass a # 8 x 1 1/2" screw through both parts and secure with a lock washer and hex nut.
4. From the center of the insulator, measure downward to a point that is 13 in (33 cm) along tube (B) and make a pencil mark.
5. From the center of the insulator, measure upward to a point that is 9 3/8" (23.8 cm) along tube (B1) and make a pencil mark.
6. Locate coil assembly 80/40 meter (C) and slide the clamp at the outer end of the larger 80 meter coil over tube (B1), lowering the entire assembly until the middle clamp can be positioned around the insulator between tube (B) and tube (B1).

NOTE: The middle clamp may have to be pulled open slightly to pass the bolt that goes through tube (B1) and the insulator.

7. Position the center coil clamp of coil assembly 80/40 meter (C) in the center of the insulator between tube (B) and tube (B1). Pass a #10 x 1" screw through the clamp as shown. Secure with a flat washer, lock washer and wing nut.

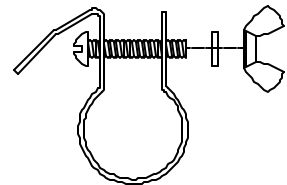

ASSEMBLY

NOTE: The outer tab of this clamp may be bent back slightly to provide clearance for the bolt, bending it back into place after assembly.

8. Stretch the 40 meter (smaller) coil on the coil assembly 80/40 meter (C) until the top of the upper clamp is even with the upper mark. Secure with a #10 flat washer, lock washer and wing nut.
9. Stretch the 80 meter (larger) coil on the coil assembly 80/40 meter (C) until the bottom of the lower clamp is even with the lower mark. Secure with a #10 flat washer, lock washer and wing nut.
10. Locate the capacitor assembly 80/40 meter (D) and install capacitor bracket 80 meter (D1) on the larger 200 pF capacitor using the installed screw.

NOTE: DO NOT USE EXCESSIVE FORCE OR OVER TIGHTEN THE SCREWS ON EITHER CAPACITOR AS YOU WILL DAMAGE THEM. DO NOT DROP THIS ASSEMBLY AS YOU MAY FRACTURE THE CAPACITOR'S CERAMIC SHELL.

11. Locate capacitor bracket 40 meter (D2) and install on the smaller 67 pF capacitor as above.
12. Install the above assembly onto the #10 screw protruding from the tab of the center clamp on the coil assembly 80/40 meter (C). Align capacitor bracket 80 meter (D1) alongside the larger 80 meter coil of coil assembly 80/40 meter (C). Secure with a #10 flat washer, lock washer and hex nut.
13. Attach the tab end of capacitor bracket 80 meter (D1) to tube (B) with capacitor bracket clamp and secure with # 8 x 1" screw, lock washer and a hex nut.
14. Attach the tab end of capacitor bracket 40 meter (D2) to tube (B1) as above.
15. Insert the un-slotted end of tube (E) into tube (B1) and secure with a # 8 x 1 1/2" screw, lock washer and hex nut.
16. Locate coil support tube 30 meter (O) and measure to a point 9 7/8 in (25.1 cm) down from the plastic insulator. Mark this point with a pencil.
17. Locate coil support tube 30 meter L bracket (O1) and place the tabbed end inside of the coil support tube 30 meter (O) securing it with a # 8 x 3/4" screw, lock washer and hex nut.
18. Place a #10 washer, lock washer and wing nut on the lower single clamp of

ASSEMBLY

coil/capacitor assembly 30 meter (P).

19. Place a #10 washer, lock washer and hex nut on both upper clamps of coil/capacitor assembly 30 meter (P).
20. Pass the lower single clamp of coil/capacitor assembly 30 meter (P) over the insulator end of coil support tube 30 meter (O) and slide the coil downward along the tube until the upper edge of the upper clamp is flush with the end of the insulator. Align the upper clamp with the coil support tube 30 meter L bracket (O1) and tighten the hex nut.
21. Stretch the coil until the bottom of the bottom clamp on the coil/capacitor assembly 30 meter (P) is even with the mark on coil support tube 30 meter (O) and tighten the wing nut.
22. Slide the remaining clamp from the above assembly over tube (E) and position it so the coil support tube L bracket (O1) is even with fourth turn, counting from the top of the 40 meter coil on the coil assembly 80/40 meter (C) and tighten the hex nut.
23. Hook the coil support tube 30 meter L bracket (O1) around the fourth turn of the 40 meter coil on coil assembly 80/40 meter (C). Secure with a # 8 x 3/4" screw, lock washer and hex nut.
24. Attach strip 17 meter (X) to the bolt that fastens the coil to the plastic insulator between the coil and the upper clamp of the Coil Assembly 17 Meter A-17-12 (W). Use the attached flat washer, lock washer and hex nut.
25. Attach the strip 12 meter (Z) to the coil assembly 12 meter A-17-12 (Y) in the same way.
26. Loosen the #10 hex nut on the bottom clamp and the wing nut on the upper clamp of coil assembly 17 meter A-17-12 (Y) and slide the assembly over the upper end of tube (E) with the insulator end up.
27. Slide the unit down until the lower clamp of the coil assembly 17 meter A-17-12 (Y) rests on the upper clamp of the coil/capacitor assembly 30 meter (O).
28. Tighten the hex nut and stretch the coil so that the distance between the upper edge of the lower clamp and the lower edge of the upper clamp is 10 1/2 in (26.7 cm).
29. Install the coil assembly 12 meter A-17-12 (Y) in the same way, so the lower edge of the lower clamp is about 2 in (5.1 cm) above the upper clamp of the coil assembly 17 meter A-17-12 (W). This distance is not critical.

ASSEMBLY

30. Tighten the hex nut and stretch the coil so that the distance between the upper edge of the lower clamp and the lower edge of the upper clamp is 8 3/4 in (22.2 cm).
31. Position wire clamp 0.875" 15 M w/insulator (K) around tube (F) and use a # 8 x 1" screw, lock washer and hex nut finger tight.
32. Slide wire clamp 0.875" 6 M w/insulator (V) around tube (F).
33. Insert the un-slotted end of tube (G) into the slotted end of tube (F) and secure with a # 8 x 1 1/4" screw, lock washer and hex nut.
34. Position wire clamp 0.750" 6 M w/insulator (U) around tube (G).
35. Locate wire clamp 0.750" 15 M w/insulator (N) and position it around tube (G).
36. Insert the un-slotted end of tube (H) into the slotted end of tube (G) and secure with a # 8 x 1" screw, lock washer and hex nut.
37. Position wire clamp 0.625" 6 M w/wire (T) around tube (H) so the top edge is 33 1/4 in (84.5 cm) from the upper end of the tube.
38. Pass the free end of the stranded wire from wire clamp 0.625" 6 M w/wire (T) through the small hole in wire clamp 0.750" 6 M w/insulator (U).
39. Line up and position the bottom edge of wire clamp 0.875" 6 M w/insulator (V) 58" (1.5 m) from the upper edge of wire clamp 0.625" 6 M w/wire (T) and tighten.
40. Pass the free end of the stranded wire from wire clamp 0.625" 6 M w/wire (T) through the small hole in wire clamp 0.875" 6 M w/insulator (V). Loop the free end of the wire around itself. Do not cut off the excess.
41. Center and align wire clamp 0.750" w/insulator (U) and tighten.
42. Locate wire clamp 0.625" 15 M w/insulator (M) and position it around tube (H).
43. Insert the un-slotted end of tube (I) into the slotted end of tube (H) and secure with a # 8 x 1" screw, lock washer and hex nut.
44. Position wire clamp 0.500" 15 M w/wire around tube (I) so the top edge is 13.5 in (34.3 cm) from the upper end of the tube and on the opposite side from the 6 meter assembly.

ASSEMBLY

45. Measure from the rivet of wire clamp 0.500" 15 M w/wire (L) to a point 11 ft 3 in (3.4 m) along the stranded wire and mark this point.

46. Pass the free end of the stranded wire from wire clamp 0.500" 15 M w/wire (L) through the small holes in wire clamp 0.625" 15 M w/insulator (M) and wire clamp 0.750" 15 M w/insulator (N) as shown.

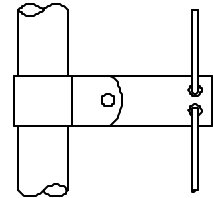

47. Loop the end of the wire through the hole in wire clamp 0.875" 15 M w/insulator (K) sliding it on tube (F) until the mark on the wire appears. Wind the wire back on itself. Do not cut off the excess wire.

48. Line up wire clamp 0.875" 15 M w/insulator (K), wire clamp 0.750" 15 M w/insulator (N) and wire clamp 0.625" 15 M w/insulator (M) with wire clamp 0.500" 15 M w/wire (L) and tighten all clamps making sure the wire is moderately taut but not enough to cause the upper tubing section to bow.

49. Place the protective cap on one end of tube (J).

50. Slide the uncapped end of tube (J) into the slotted end of tube (I) until only 25 in (63.5 cm) extends and secure with compression clamp small adjustable.

NOTE: In the following steps the antenna will be assembled and raised to its full vertical height. If the antenna is to be installed in an elevated position where it is unsafe or inconvenient to make in-place adjustments, the antenna may have to be installed in one piece. It will probably be necessary to raise and lower it and its supporting structure a number of times to arrive at the *ideal* adjustment on all bands. If so, every precaution should be observed in order to avoid possible contact with power lines and to prevent structural failure that can cause injury to persons or property.

51. Place the lower end of tube (B) through tube (E) over the insulator on tube (A) w/insulator. Line up the holes and secure it with a # 8 x 2" screw, lock washer and hex nut.

WARNING: AVOID POWER LINES!

52. Raise the assemble of tube (F) through tube (J) and slide the lower end into tube (E) fastening it securely with a # 8 x 1 1/4" screw, lock washer and hex nut.

ASSEMBLY

53. Install coax 75 ohm matching (R) as shown placing the lug from the center conductor over the screw on tube (B) and the braid over the screw on tube w/insulator (A).
54. Place # 8 washers over each screw and install coil (Q) base matching. Secure with washers, lock washers and hex nuts.

NOTE: Attach radials and ground to tube w/insulator (A) using the remaining # 8 hardware.

WARNING: MAKE SURE THAT THE STATION EQUIPMENT IS CONNECTED TO A GOOD EARTH GROUND! DO NOT HANDLE CABLE CONNECTED TO STATION EQUIPMENT WITHOUT FIRST DISCONNECTING THE EQUIPMENT FROM THE POWER MAINS. YOU COULD BE ELECTROCUTED!

55. Connect coax 75 ohm matching (R) to any length of 50-53 ohm coaxial cable. Connector PL258 (S) is provided. Seal the connection with the small roll of Konnector-Kote.

CHECKOUT AND ADJUSTMENT

The dimensions and coil settings given above should produce reasonably low VSWR readings over the entire 10, 15, 20 and 30 meter bands and over at least 250 kHz of the 40 Meter band. Bandwidth on 80/75 meters should be at least 30 kHz for VSWR of 2:1 or less at the low end of the band and may be as much as 100 kHz at the high end of the band, depending on the efficiency of the ground system used, greater bandwidth being associated with lossy ground systems. It should be remembered that on those bands where the physical height of a vertical antenna is less than a quarter wavelength, the earth (or the resonant radial system in above-ground installations) will have a good deal to do with VSWR and antenna tuning, bandwidth and overall performance.

Low VSWR by itself does not mean that a vertical antenna is operating efficiently, and if low VSWR is obtained with no more than the usual *quick and dirty* ground connection, it most likely means the opposite. In general, poor operation or improper tuning of vertical antennas can usually be attributed to inadequate (or even reactive) ground systems or to other vertical conductors in the vicinity of the antenna. For these reasons it is suggested that the antenna be placed as much in the clear as possible and used with the best ground system that conditions permit. For a more complete discussion of the interrelationships between vertical antenna efficiency, bandwidth, VSWR, etc., a standard text such as the A.R.R.L. Antenna Book is recommended. See also the material included at the end of these instructions.

CHECKOUT AND ADJUSTMENT

For adjustment purposes a simple VSWR indicator may be used. More accurate measurements may be made at the antenna (i.e., at the junction of the coax 75 ohm matching (R) and the main transmission line) than at the input end of the line, but the tuning conditions that exist at the transmitter will usually be of greater interest in that one's principal concern will be to couple power from the transmitter into the transmission line.

1. Determine the frequency at which VSWR is lowest on 80/75 meters. The coil setting given earlier should produce resonance and lowest VSWR at approximately 3700 kHz. To raise the frequency of resonance of the lowest VSWR, simply loosen the wing nut on the lower coil clamp of the coil assembly 80/40 meter (C) coil on tube (B) and stretch the coil a bit more. To lower the frequency, compress the coil. A 1 in (2.5 cm) change in the setting of this coil will produce a frequency shift of approximately 125 kHz.

NOTE: Remember that the antenna tunes very sharply in this range and that high values of VSWR may be encountered only a few kHz either side of the lowest VSWR readings, so it would be well to take VSWR readings every 25 kHz or so to avoid *running past* the frequency of resonance and lowest VSWR.

NOTE: To minimize interference to other stations and to avoid erroneous reading use only enough power to produce full-scale deflection of the meter in the *forward* or *r.f. out* position.

2. Once the proper coil setting has been found for the desired band segment, coil (Q) base matching at the base of the antenna may be adjusted for even lower VSWR. If earth losses are moderate to high a good match may be possible if coil (Q) base matching is left fully compressed; if earth losses are low (as with an extensive radial system) coil (Q) base matching may have to be stretched to twice its compressed length or more for a good match. In any case, a single setting for coil (Q) base matching should suffice for operation over most of 80/75 meters provided the 80 meter coil is readjusted for each different band segment.
3. Determine the frequency of minimum VSWR on 40 meters. The coil setting given earlier should produce resonance and lowest VSWR at approximately 7150 kHz. The 40 meter VSWR and resonance curve may be shifted in the same manner as on 80/75 meters by changing the setting of the upper coil clamp of coil assembly 80/40 meter. On this band the setting is much less critical, and a 1 in (2.5 cm) change in the clamp setting will shift the VSWR curve approximately 80 kHz. Be sure to loosen the clamp around tube (E) that supports the 30 meter assembly and to reposition it as needed to avoid distorting the 40 meter coil.

CHECKOUT AND ADJUSTMENT

4. Check VSWR on 20 meters. Tuning is quite broad on this band because the antenna is physically much taller than a quarter wavelength. To raise the frequency of the lowest VSWR, reposition the 30 meter assembly so that the coil support tube 30 meter L bracket (O1) can be replaced on the next lower turn of the 40 meter coil. Alternatively, to lower the frequency of lowest SWR, reconnect the coil support tube 30 meter L bracket (O1) to the next higher turn of the 40 meter coil. In some cases moving the tap point a full turn up or down may cause more of a frequency shift than is desired, in which case the entire 30 meter assembly may be rotated around tube (E) to permit adjustments of less than one full turn.
5. Check VSWR on 15 meters. The VSWR curve may be shifted upward or downward by changing the length of the stranded wire between wire clamp 0.500" 15 M w/wire (L) and wire clamp 0.875" 15 M w/insulator (K). To raise the frequency, simply shorten the wire by wrapping a longer *tail* back on itself and sliding the lower clamp upward to maintain tension. To lower frequency, feed more of the *tail* back through the hole in the insulator to increase the length of the wire between wire clamp 0.500" 15 M w/wire (L) and wire clamp 0.875" 15 M w/insulator (K). A change of 2 in (5.1 cm.) will shift the VSWR curve approximately 300 kHz.
6. Check VSWR on 10 meters. To raise the resonant frequency loosen the small hose clamp over the slotted end of tube (I) and slide tube (J) farther into tube (I); to lower the frequency, slide tube (J) farther out of tube (I) and retighten the hose clamp. A length change of 3 in (7.6 cm) should move the VSWR curve approximately 200 kHz.
7. Check VSWR on 30 meters. To raise frequency, loosen the wing nut on the bottom coil clamp of coil/capacitor assembly 30 meter (P), stretch the coil and retighten the wing nut. To lower frequency, compress the coil. A change of only 1/4 in (6.4 mm) will shift the VSWR curve approximately 100 kHz. Large changes in the setting of coil/capacitor assembly 30 meter (P) may affect 20 and 40 meter tuning, in which case it may be necessary to repeat steps 3 and 4. In general, the point at which the 30 meter coil taps on to the 40 meter coil will be the major factor in 20 meter tuning.
8. Check VSWR on 17 meters. To move the SWR curve to a higher frequency loosen the wing nut on the upper coil clamp and **STRETCH** the coil about 1/4 in (6.4 mm) at a time. To move the SWR curve to a lower frequency range **COMPRESS** the coil a like amount.
9. Check VSWR on 12 meters. Stretch the 12 meter coil in increments of 1/4 in (6.4 mm) or so to raise the resonant frequency, or compress the coil a like amount to lower the resonant frequency.

CHECKOUT AND ADJUSTMENT

10. Check VSWR on 6 meters. To raise the frequency of the lowest VSWR, shorten the length of the wire and to lower frequency increase the wire length. Alternatively, the upper clamp and the entire 6 meter assembly may be placed higher on the antenna to lower frequency or lower to raise it.
11. Adjustments for 40, 30, 20, 15, 17, 12, 10 and 6 meters should have little or no effect on the previous adjustments for 80/75 meters, but a final VSWR check for this band should be made as in step 1 above.

NOTE: In above-ground installations it will usually be found that resonance and lowest VSWR occur at slightly higher frequencies on all bands compared to ground-level installations. Therefore on 15 and 10 meters, where length adjustment is the means of getting antenna resonance, it is recommended that the length of the stranded-wire between wire clamp 0.500" 15 M w/wire (L) and wire clamp 0.875" 15 M w/insulator (K) be increased approximately 3 in (7.6 cm.) and that tube (J) be extended approximately 6 in (15.2 cm.) beyond the original dimensions given if any above-ground installation is contemplated. These are merely recommended preliminary settings, for it is impossible to indicate precise settings that will produce resonance or lowest VSWR at a given frequency in all installations.

In the preceding steps it has been assumed that the antenna has been installed in a more or less clear spot away from other vertical conductors such as TV antenna feedlines, towers and masts, and that a minimal ground system (or a system of resonant radials in the case of above-ground installations) has been installed.

If those fairly basic conditions have not been met it is likely that resonance and low VSWR will be impossible on some or even all bands. One should bear in mind that VSWR, even with a resonant antenna, will depend in large measure on local ground conductivity, height above ground in the case of an elevated antenna, the extent of the radial, counterpoise or other ground system used, and on other factors over which the operator may have little or no control. Fortunately, the evils of VSWR greater than unity have been grossly exaggerated in recent decades, and the only practical difference between a VSWR of unity and one of, say, 3:1 in the average case lies in the reluctance of modern equipment to deliver full power into lines operating at the higher VSWR without the help of a transmatch or other outboard matching device. Transmitters having so-called broadband solid-state output circuits (no tuning or loading controls) may be especially troublesome in this regard, whereas the older vacuum tube pi-network transmitters can usually be adjusted for maximum output over a tuning range

THEORY OF OPERATION

where the VSWR does not exceed 2:1. The first L/C circuit generates enough reactance to bring the whole HF9V to resonance on 80 meters allowing it to act as a $1/4 \lambda$ radiator. It also generates enough *capacitive* reactance to produce another discrete resonance at about 11 MHz. The second, 40 meter L/C circuit generates enough reactance to resonate the whole HF9V allowing it to act as a $1/4 \lambda$ radiator. In order to minimize conductor and I^2R losses on 80 and 40 meters where the antenna is physically shorter than a $1/4 \lambda$ and thus operates with lower values of radiation resistance, large-diameter self-supporting inductors and low-loss ceramic capacitors are employed. Where the height of the HF9V is slightly greater than a $1/4 \lambda$ on 30 meters, an L/C series tuned circuit taps onto the 40 meter coil for the extra inductance to pull the earlier 11 MHz secondary resonance down to 10 MHz. At the same time, a portion of the 40 meter coil is shorted out which allows the circuit to resonate on 30 meters. The addition of this circuit also produces additional resonances at 14 MHz and 28 MHz. On 20 meters the entire radiator operates as a $3/8 \lambda$ vertical with much higher radiation resistance and VSWR bandwidth than conventional or *trapped* antennas having a physical height of $1/4 \lambda$ or less. Because the 20 meter radiation resistance will be several times greater than that of conventional vertical antennas, an electrical $1/4 \lambda$ section of 75-ohm coax is used as a *geometric mean* transformer to match the 100-odd S of feedpoint impedance on that band to a 50 S main transmission line of any convenient length. The HF9V operates as a slightly extended $1/4 \lambda$ radiator on 15 meters, a $1/4 \lambda$ stub decoupler providing practically lossless isolation of the upper half of the antenna on that band. On 10 meters the HF9V becomes a $3/4 \lambda$ radiator with considerably greater radiation resistance and efficiency than $1/4 \lambda$ trapped types. On 17 and 12 meters the coils act as *packets of reactance* which allow the entire radiator to operate as a $1/2 \lambda$ or $5/8 \lambda$ vertical. Capacitance for these circuits comes from what exists between the windings, the windings and the radiator and the capacitance hat. On 6 meters the vertical wire together with the adjacent section of antenna form a short-circuited $1/4 \lambda$ transmission line which cancels current flow. At the lower, open end of the $1/4 \lambda$ section a very high impedance is created that effectively divorces the upper part of the antenna leaving the lower section to radiate as a $3/4 \lambda$ vertical.

ELECTRICAL AND MECHANICAL SPECIFICATIONS

Height (adjustable): 26 ft (7.9 m)

Shipping Weight: 14 lbs (6.3 kg)

Feedpoint Impedance: Nominal 50 ohms through included matching line.

VSWR at resonance: 1.5:1 or less all bands

Power rating: 2 kW PEP 75/80, 40, 20, 15, 10 meters; 800 W PEP 17, 12 meters; 500 W PEP 6, 30 meters

Wind loading area: 2.2 ft² (.2 m²)

Bandwidth for VSWR of 2:1 or less: 1 MHz 6 meters, entire band 10, 12, 15, 17, 20, 30 meters, 250-300 kHz 40 meters, 40-100 kHz 75/80 meters

GUYING

The HF9V is designed to survive winds of up to 80 mph (129 kph) without guying in the absence of ice loading or heavy precipitation, but over a period of time it is to be expected that frequent or even constant flexing or vibration will reduce the chances for survival in winds that would not damage a newly installed antenna. Therefore in areas of frequent or heavy winds a set of short non-conductive guys should be used to reduce the stresses that wind loading will impart to the lower sections of the antenna. In this connection, it should be noted that light nylon twine is totally unsuitable as guying material because it has too much stretch per unit length, although the heavier sizes of nylon rope (or even sash cord) may be suitable if used in short runs. Polyethylene rope may be used, but because some grades tend to deteriorate fairly rapidly, periodic inspection should be made. A single set of guys placed just above the 30 meter circuit will contribute greatly to the stability and the longevity of the antenna, provided that the guys retain a slight amount of slack and do not come off at too steep an angle. At Angles of less than 45° the guys begin to exert a downward compressive force on the structure that can be more of a threat to survival than lateral wind loading on an unguyed structure. Under no circumstances should guys be placed higher than one-third of the way up the antenna. The upper two-thirds of the HF9V has little more than its own weight to support, so these sections may be allowed to bend with the wind with no serious risk of damage. It is the lower third of the antenna that must support both the weight of the upper sections and the wind loading on them and are thus more likely to receive damage in severe winds.

PARTS LIST

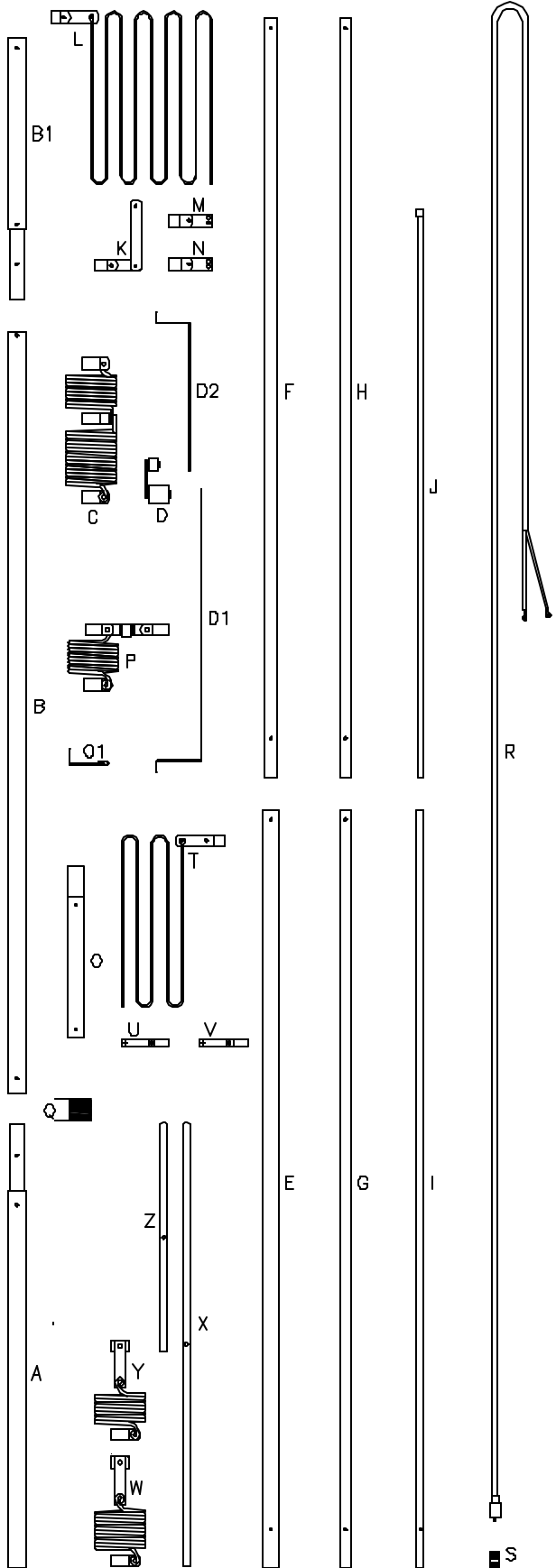

A	VS00278Z	Tube A W/Insulator
B	VB00115A	Tube B
B1	VS00365Z	Tube B1 W/Insulator
C	VS00145Z	Coil Assembly 80/40 Meter
D	VS00190Z	Capacitor Assembly 80/40 Meter
D1	VB00150A	Capacitor Bracket 80 Meter
D2	VB00220A	Capacitor Bracket 40 Meter
E	VB00123A	Tube 1.000" x 48"
F	VB00124A	Tube 0.875" x 48"
G	VB00125A	Tube 0.750" x 48"
H	VB00126A	Tube 0.625" x 48"
I	VB00127A	Tube 0.500" x 48"
J	VB00175A	Tube 0.375" x 36"
K	VR00286Z	Wire Clamp 0.875" 15 M W/Insulator
L	VR00280Z	Wire Clamp 0.500" 15 M W/Wire
M	VR00281Z	Wire Clamp 0.625" 15 M W/Insulator
N	VR00282Z	Wire Clamp 0.750" 15 M W/Insulator
O	VS00204Z	Coil Support Tube 30 Meter
O1	VB00176A	Coil Support Tube 30 Meter L Bracket
P	VS00249Z	Coil/Capacitor Assembly 30 Meter
Q	VS00137Z	Coil Q Base Matching
R	VS00223Z	Coax 75 Ohm Matching
S	VG00228Z	Connector PL-258
T	VR00331Z	Wire Clamp 0.625" 6 M W/Wire
U	VR00332Z	Wire Clamp 0.750" 6 M W/Insulator
V	VR00314Z	Wire Clamp 0.875" 6 M W/Insulator
W	VS00503Z	Coil Assembly 17 Meter A-17-12
X	VB00215A	Strip 17 Meter
Y	VS00258Z	Coil Assembly 12 Meter A-17-12
Z	VB00216A	Strip 12 Meter
HARDWARE		
2	VJ00077Z	# 8 x 3/4" Screw
5	VJ00078Z	# 8 x 1" Screw
2	VJ00079Z	# 8 x 1 1/4" Screw
2	VJ00114Z	# 8 x 1 1/2" Screw
1	VJ00109Z	# 8 x 2" Screw
16	VJ00080Z	# 8 Lock Washer
6	VJ00083Z	# 8 Flat Washer
16	VJ00081Z	# 8 Hex Nut
1	VJ00131Z	#10 x 1" Screw
7	VJ00133Z	#10 Lock Washer
7	VJ00132Z	#10 Flat Washer
3	VJ00134Z	#10 Hex Nut
4	VJ00135Z	#10 Wing Nut
1	VF00089Z	Protective Cap 3/8"
2	VB00143A	Capacitor Bracket Clamp
1	VJ00144Z	Compression Clamp Small Adjustable
.05	VD00050Z	Konnektor-Kote (1" x 8")

PICTORIAL

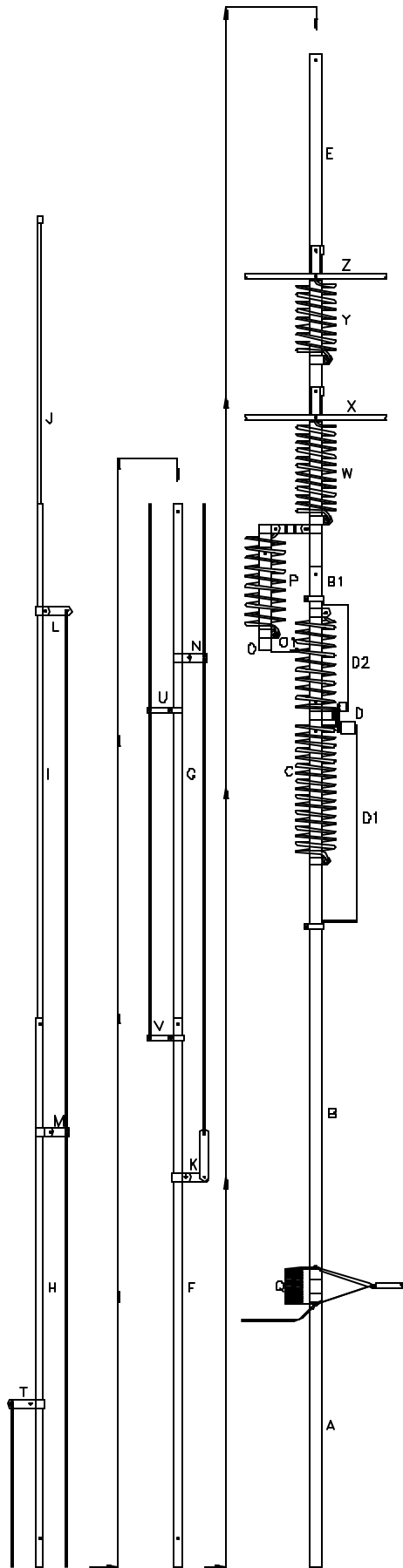

Feedline Detail

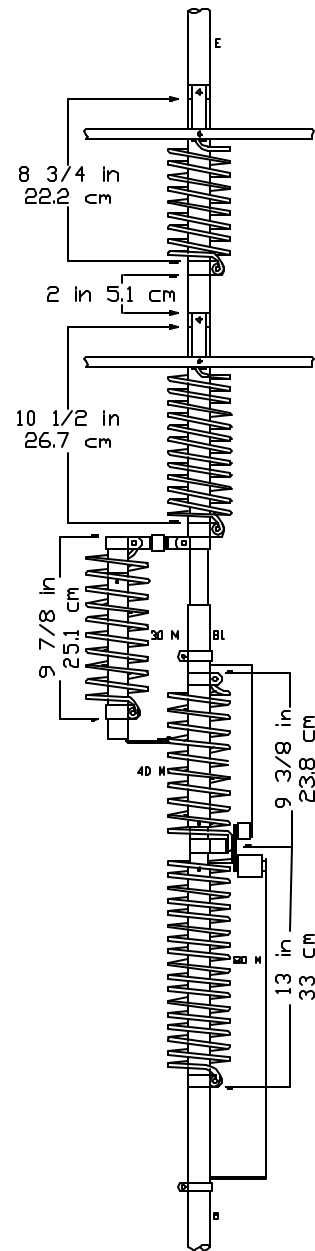
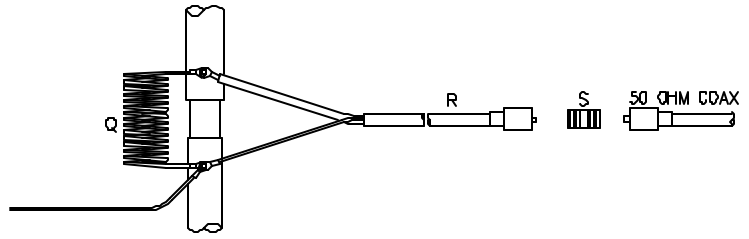

TECH NOTES—GROUND RADIAL SYSTEMS

MOUNTING TUBE INSTALLATION

When tube w/insulator (A) is ground mounted, it should be protected against corrosion if placed in concrete, damp acidic or alkaline soil. Asphalt roofing compound, polyurethane varnish or other sealant that protects against moisture may be used.

Concrete may be used in areas of high winds for greater strength, in which case the post may be twisted slightly during setting for easy removal later.

Tube w/insulator (A) must be installed in a hole approximately 21 in (53.3 cm) deep so that the upper end of the fiberglass insulator is approximately 7 in (17.8 cm) above ground level. Pack earth tightly around tube w/insulator (A) so that it remains vertical.

NOTE: HAMMERING TUBE W/INSULATOR (A) INTO THE EARTH MAY CAUSE THE INSULATOR TO SPLINTER. If the post must be hammered into the earth, protect the end of the insulator with a block of wood

NOTE: DO NOT USE U-BOLTS TO ATTACH TUBE W/INSULATOR (A) TO A MAST, TOWER ETC. U-BOLTS WILL EVENTUALLY CUT INTO THE TUBING AND WEAKEN THE INSTALLATION. If U-bolts must be used, place a larger diameter metal, such as the MPS Mounting Post Sleeve over tube w/insulator (A). Similar precautions should be observed when using TV style towers with locking bolts.

The RMK-II Roof Mounting Kit includes the MPS as well as the STR-II Stub Tuned Radial Kit.

GROUND MOUNTING

A vertical antenna in its simplest form, is electrically equivalent to one-half of a dipole antenna stood on end. When the antenna is mounted close to the ground, the earth below takes the place of the "missing" half of the dipole. If ground conductivity is fair to good, a short metal stake or rod may provide a sufficiently good ground connection for resonant and low SWR operation on the bands for which the antenna is designed. This basic arrangement is shown in figure 1.

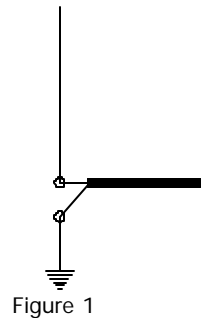

Figure 1

The way it works is that the capacitance between the vertical radiator and the ground causes *return* currents to flow along the earth's surface back to the transmitter. If they have to come back along untreated lossy earth they get back to the source greatly attenuated. This *return* loss is like a resistor in series with the antenna radiation resistance and will therefore affect the feed point impedance.

TECH NOTES—GROUND RADIAL SYSTEMS

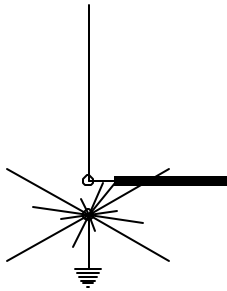

Figure 2

In almost every case the efficiency of a vertical antenna will be greater if radial wires are used to improve ground conductivity as in figure 2. It's important to note that there's no point in cutting radials to any particular length when ground mounting because the earth will detune them anyway. All you want to do is make the surface of the earth around the antenna more conductive than it is ordinarily.

If you can't copper-plate the backyard, the best approach is to run out as many radials as possible, each as long as possible around the antenna in all directions. Radials may be left on top of the ground however they should be buried for the sake of pedestrians and lawnmowers.

How long should radials be? A good rule is no shorter than the antenna is tall because 50% of your losses will occur in the first 1/4 λ out from the antenna. If you have more than a dozen radials, they must be longer to get the most out of them which is why the FCC specifies 113 wires each .4 λ for AM broadcast stations—the equivalent of a zero-loss ground plane. Obviously, for most ham work this would be overkill.

In some cases wire mesh (i.e. chicken wire) may be used as a substitute for radial wires and/or a ground connection, the mesh or screen acting as one plate of a capacitor to provide coupling to the earth beneath the antenna.

It should be noted that a ground rod is useful only as a d.c. ground or as a tie point for radials. It does little or nothing to reduce ground losses at r.f. regardless of how far it goes into the ground.

Bare wire, insulated, any gauge, it doesn't matter. The current coming back along any one wire won't amount to that much.

EFFICIENCY

The importance of reducing losses in the ground system can be seen from an examination of a vertical antenna's feedpoint impedance which at resonance consists of three components: antenna radiation resistance; conductor loss resistance; and earth loss resistance. An unloaded quarter-wave vertical antenna has a radiation resistance of about 35 ohms with negligible ohmic or conductor loss, but ground loss resistance may be very great if no measures are taken to reduce it, and in some cases ground loss R may even exceed the antenna radiation resistance. These three components may be added together to arrive at the feedpoint **impedance** of a **resonant** (no reactance) antenna. For the sake of illustration, assume that the ground loss beneath a quarter wavelength vertical antenna is 15 ohms, that conductor loss resistance is zero, and that the radiation

TECH NOTES—GROUND RADIAL SYSTEMS

resistance is the textbook figure of 35 ohms. The feedpoint impedance would then be $15 + 0 + 35 = 50$ ohms, and the antenna would be perfectly matched to a 50 ohm coaxial line. Since the radiation resistance is an index of the amount of applied power that is consumed as useful radiation rather than simply lost as heat in the earth or in the conductor, the radiation resistance must be kept as high as possible in relation to the total feedpoint impedance for maximum efficiency. Efficiency, expressed as a percentage, may be found by dividing the radiation resistance by the total feedpoint impedance of a resonant antenna, so under the conditions assumed above our vertical antenna would show an efficiency of $35/50 = 70\%$. As a vertical antenna is made progressively shorter than one-quarter wavelength the radiation resistance drops rapidly and conductor losses from the required loading inductors increase. A one-eighth wave inductively loaded vertical would have a radiation resistance of something like 15 ohms and coil losses (or trap losses for multiband antennas) would be in the range of 5 ohms. Assuming the same value of ground loss resistance (15 ohms), the feedpoint impedance would become $15 + 5 + 15 = 35$ ohms and the efficiency would be $15/35 = 43\%$. From the above calculations it is clear that the shorter a vertical antenna must be the less efficient it also must be for a given ground loss resistance. Or to state the matter another way, more elaborate ground or radial systems must be used with shorter verticals for reasonable efficiency. If the ground loss of resistance of 15 ohms from the preceding example could be reduced to zero ohms, it is easy to show that the efficiency of our one-eighth wavelength loaded vertical would increase to 75%. Unfortunately, more than 100 radials each one-half wavelength long would be required for zero ground loss, so lower efficiencies with shorter radials must usually be accepted for the sake of convenience. In spite of their limitations, short vertical antennas over less than ideal ground systems are often more effective DX performers than horizontal dipoles which must be placed well above the earth (especially on the lower bands) to produce any significant radiation at the lower elevation angles. Verticals, on the other hand, are primarily low-angle radiators on all bands.

ABOVE GROUND (ELEVATED) INSTALLATIONS (rooftop, tower, mast. etc.)

The problem of ground loss resistance may be avoided to some extent by mounting a vertical antenna some distance above the earth over an artificial ground plane consisting of resonant (usually $1/4 \lambda$) radial wires. Four resonant radials are considered to provide a very low-loss ground plane system for vertical antennas at base heights of $1/2 \lambda$ or more. This arrangement contrasts favorably with the more than 100 radials for zero ohms loss resistance at ground level, and since $1/2 \lambda$ is only about thirty-five feet at 20 meters, very worthwhile improvement in vertical antenna performance can be realized, at least on the higher bands, with moderate pole or tower heights. At base heights below $1/2 \lambda$ more than four radials will be required to provide a ground plane of significantly greater conductivity than the lossy earth immediately below the antenna: even so,

TECH NOTES—GROUND RADIAL SYSTEMS

a slightly elevated vertical with relatively few radials may be more effective than a ground-level vertical operating over a larger number of radials if only because the former is apt to be more in the clear. Resonant radial lengths for any band may be calculated from the formula:

$$\text{Length (ft)} = \frac{240}{\text{Frequency (MHz)}}$$

Figure 3 shows the basic ground plane system for elevated verticals. Radials may slope downward as much as 45 degrees without any significant effect on operation or performance. Radials for different bands should be separated as much as possible and the far end of each radial insulated from supporting wires. Figure 4 shows a ground plane system that uses four resonant radials for 40 meters, another set of four for 20 meters, and a third set for 10 meters. A separate set for 15 meters is not ordinarily required because the 40 meter radials operate as resonant 3/4 8 radials on that band. At the lower heights the separate wires of this system may provide enough capacitance to ground to permit low SWR operation on 80/75 meters as well, but it is probable that at least one resonant radial will be required for low SWR on that band. It's important to note that cutting each conductor of rotator cable to a specific frequency will not work unless you separate it, angling each conductor away for most of its length because the longer ones will detune the shorter ones.

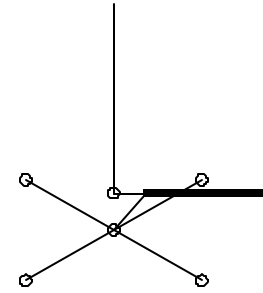

Figure 3

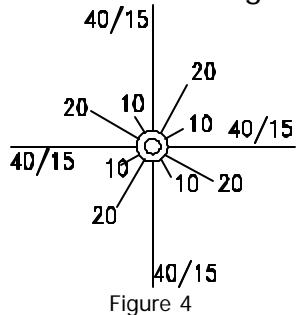

Figure 4

The 12-radial system of Figure 4 is a very good one, but it requires at least 12 tie-off points. Butternut has developed a multiband radial made of 300-ohm ribbon that resonates simultaneously on 40, 20, 15 and 10 meters. Four such radials offer essentially the same ground plane performance as the system of Figure 4 but require only 4 supports. These multiband radials plus additional wire for an 80 meter radial are available separately (our STR-II kit) or as part of the Butternut roof mounting kit (RMK-II).

There are times when physical restrictions will dictate the use of fewer than four radials, and at least one manufacturer recommends 2 radials per band, the radials for each band running 180 degrees away from each other. A simpler (and no doubt less effective) system is shown in Figure 5. Since only one resonant radial is used per band the antenna will radiate both vertically and horizontally polarized energy, and the pattern will not be completely omnidirectional. For true ground plane action and predominantly vertical polarization no fewer than three equally-spaced radials should be used.

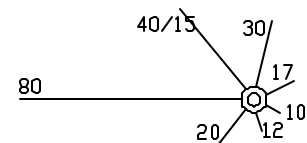
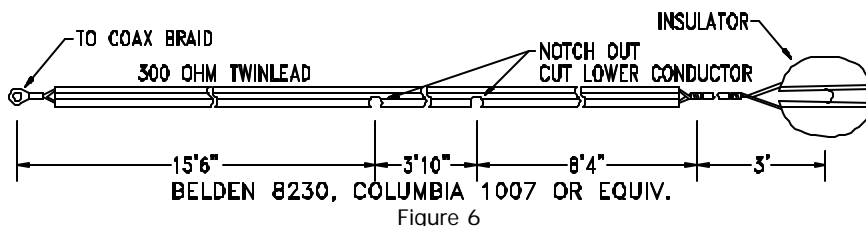

Figure 5

TECH NOTES—GROUND RADIAL SYSTEMS

Figure 6 illustrates the construction of a multi-band radial which is resonant on 40, 20, 15 and 10 meters. Good quality 300 ohm TV ribbon lead should be used (velocity factor is critical), and the conductors should employ at least one strand of steel wire to support the weight of the radial. Four such radials will be the practical equivalent of the system shown in figure four for operation on 40 through 10 meters.



Regardless of the number of radials used in either elevated or ground level systems, all radials should be attached to the ground connection at the antenna feedpoint by the shortest possible leads. An elaborate radial system at ground level, for example, cannot be used with a vertical antenna on a rooftop or on a tall tower, for the length of the ground lead would effectively become part of the antenna, thus detuning the system on most or all bands.

METAL TOWERS AND MASTS

If a metal mast or tower is used to support a vertical antenna all radials should be connected to the mast or tower at the ground connection of the antenna feedline. This is because one of the functions of a resonant radial is to detune a supporting metal structure for antenna currents that might otherwise flow on the structure and thus turn the vertical antenna system into a vertical long wire with unwanted high-angle radiation.

OTHER MOUNTING SCHEMES

In cases where a resonant vertical antenna may neither be ground mounted nor used with an elevated ground plane, operation may still be possible if connection can be made to a large mass of metal that is directly connected or capacitively coupled to the ground, e.g., central air conditioning systems or structural steel frames of apartment buildings. Some amateurs have reported good results with vertical antennas extended horizontally or semi-vertically from metal terraces which serve as the ground connection. Alternatively, a quarterwave vertical may be window mounted if a short ground lead to a cold water pipe or radiator can be used. If a long lead must be used, tuned radials may be required for resonance on one or more bands. Great care should be exercised in such installations to avoid power lines and to keep the antenna from falling onto persons or property.

MOBILE HOME AND RV INSTALLATION

The principles of vertical antenna installations for use on mobile homes or RV's are the same as for other installations, and they all boil down to two main considerations. The first is that of erecting the vertical in the clearest possible

TECH NOTES—GROUND RADIAL SYSTEMS

spot, away from obstacles (including the MH or RV) that can interfere with radiation from the antenna. The second is that of installing the best possible ground system beneath the antenna in order to minimize losses from r.f. currents flowing in the earth below the antenna. Fortunately, the metal bodies of both MHs and RVs can be used as highly conducting ground planes for vertical antennas in exactly the same way that automobile bodies, etc., provide the ground system for shorter vertical antennas for mobile operation. The metal body of an automobile, MH or RV may be viewed as one plate of a capacitor. Since the surface area of even a small automobile is quite large and in close proximity to the earth, its body is tightly coupled to the earth below and may be considered simply as an extension of the earth itself—a kind of hill as far as radio frequencies are concerned, but one having higher conductivity than the earth itself. RVs and especially MHs, having much greater surface area, will therefore provide a more extensive and effective ground system than a large number of radial wires occupying the same space as the MH or RV.

As in mobile installations, a vertical antenna may be mounted almost anywhere on the body of the vehicle or MH and made to operate with reasonably low VSWR, but it is generally considered that the best possible location for a mobile antenna is in the middle of the roof of the vehicle, i.e., at the center of the vehicle's ground plane and at a point where the antenna will not be in the "shadow" of any part of the vehicle. It is not usually convenient, or even practical to install a relatively tall vertical on the roof of an RV or MH for any number of reasons, so the next best procedure would be to install a vertical antenna with its base at the same level as the roof, preferably near the middle of one of the longer sides. The exact way in which this may be done is a matter of convenience, but a short mast extending from ground level to the roof of the MH and RV and placed alongside the building or RV would provide a stable and sturdy support with a minimum of mounting brackets and other modifications to the RV or MH. For portable operation such a mast could simply be lashed alongside the RV with the base in a shallow hole in the ground for additional support, and there would be no harm in extending the mast a few inches above the roof level to permit attachment of ropes which could be used to hold the mast firmly against the side of the vehicle and to prevent side sway.

This system has been used successfully with various types of RVs, travel trailers and even passenger automobiles during portable operation. For "L" shaped mobile homes a vertical antenna should be placed in the corner of the "L" so that the metal roof will provide groundplane coverage over 270 degrees.

TECH NOTES—GROUND RADIAL SYSTEMS

In all cases the base of the vertical antenna should not be more than a few inches away from the MH or RV so that the shortest possible lead may be run from the ground connection of the antenna to the metal body, as the length of this ground lead will effectively lengthen the antenna itself on all bands, and detuning can occur in some cases. A good electrical connection between the body of the RV or MH and the antenna is important, and in the case of mobile homes it would be a good idea to make sure that good electrical contact exists between the different parts of the metal body. Discontinuities can often lead to the production of harmonic radiation and TVI. The essential circuit connections are shown in the diagram above.

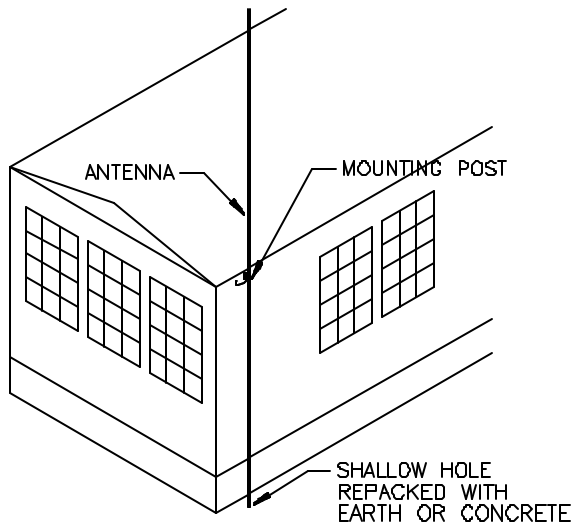
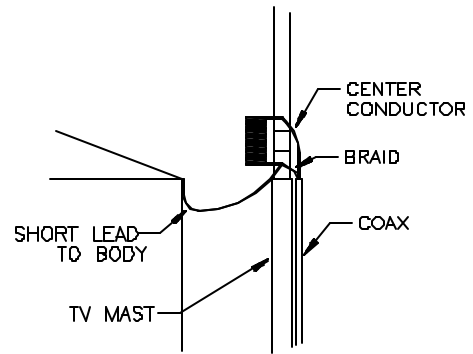

For permanent installations the bottom of the mast may be set deeper in the ground, and concrete may be used for greater strength and stability. The upper portion of the mast should be securely attached to the side of the building. Steel TV mast sections are readily available in lengths of ten feet and the mounting posts of Butternut HF verticals will slide into those which have an outside diameter of 1 1/4 inches and a wall thickness of .058 inches. Other vertical antennas may use different mounting techniques and requirements, so be sure to select a mast that will be suited to the particular situation. The main point

to keep in mind is that the mast should not extend more than a few inches above the level of the roof so that the ground lead may be kept short.

LIGHTNING PROTECTION

Modern solid state amateur equipment is particularly vulnerable to damage from lightning or static induced transients that may appear on transmission lines, and conventional air-gap lightning protectors may provide no real protection at all for solid state gear. A line of very effective lightning and static protectors has been developed by ALPHA DELTA COMMUNICATIONS, P.O. Box 571, Centerville, Ohio 45459, for use with solid state equipment, and since these devices feature much faster transient discharge times than earlier designs, they should be investigated for possible use with all vertical and other antenna systems.

TROUBLESHOOTING

Check out your installation again, looking for loose connections and checking all dimensions. Then refer to the list of possible symptoms below:

Symptom: Few or no signals heard: bands seem *dead*, SWR is very high.

Look for: Open or shorted feedline, open or shorted matching line, broken connection at base of antenna (feedpoint).

Symptom: High SWR on 20 meter; other bands OK.

Look for: Missing matching line. Antenna not properly tuned. 20 meter radials not present or wrong length. Consult instructions for tuning and radial information; install matching line *RG-11 75 ohm coax, 11 ft 4 in (345.4 cm) if solid dielectric, 13 ft 6 in (411.5 cm) if foam type*.

Symptom: High SWR on some bands, but signals heard on all bands (conditions permitting).

Look for: Missing or defective radial system. Install as per instructions and check connections to radials and ground system. Keep this connection 6 in or less.

Symptom: High SWR on one band when antenna is roof-mounted. Radials are in place, but antenna will just not tune.

Look for: Radials of wrong length or running close to metal rain gutters or roof flashing. Tune radials and/or reroute them away from metal.

Symptom: Tuning is *sharp* with narrow bandwidth on 80 meter (and 160 meter if TBR-160-S is in place).

Look for: Normal condition. The total length of the antenna represents such a small percent of a wavelength on these bands that sharp tuning is a normal condition.

Symptom: Antenna was installed on the ground and tuned OK, but tuning changed over a period of weeks or months.

Look for: Antenna installed over poor ground system. Ground conditions have changed, causing shift in resonance. Install radial system as per instructions. Check connection to radial system. When you see this problem, you may assume that a ground rod without a radial system is not enough.

Symptom: Resonant point changes during wet weather.

Look for: Normal condition.

Symptom: Insulation arcs over between 80 meter and 40 meter coils damaging fiberglass.

TROUBLESHOOTING

Look for: Operation at high power levels in areas where salt or pollution deposits have built up on the insulators. The cure is to keep insulators clean through routine maintenance.

Symptom: Intermittent operation. SWR jumps up and down suddenly, and reception is also intermittent.

Look for: Loose connections in the feedline or matching line (if used). Bad relay in rig. Bad antenna switch or connecting cable. Broken or corroded connections at the feedpoint. Bad radial/ground connection. Radial or antenna contacting metal when wind blows. Loose hardware on the antenna. Check and secure all connections.

Symptom: Antenna displays generally degraded performance after long period of time.

Look for: Lack of routine maintenance. Coax may be waterlogged or damaged. Build up of salt or pollution deposits on insulators and capacitors. Radial system corroded or rotted away. Owner must do routine maintenance at intervals, according to local conditions.

Symptom: SWR is OK on 75 meter, but goes up gradually when high power is applied. This is accompanied by heating of 200pF capacitor.

Look for: Bad ceramic capacitor. Replace.

Symptom: Antenna doesn't tune 80 meter or 160 meter, even though radials are in place and of proper length.

Look for: Antenna far out of tune; operator has not followed systematic tuning procedure. Start with suggested settings in instructions. Make an SWR chart to determine point of resonance. *Adjust coils carefully!* Remember, tuning, is *sharp* on these bands, so it is easy to pass the resonant point, then assume erroneously that the antenna isn't tuning.

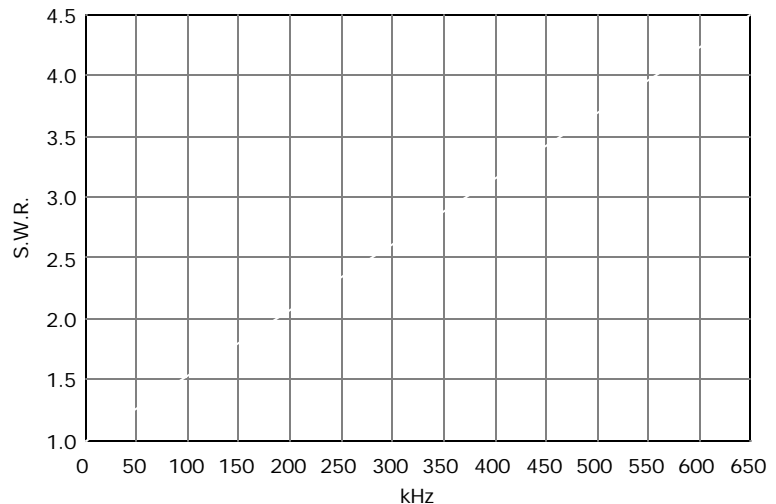

BEFORE you call the manufacturer for help, please double check your installation, including all connections and dimensions. Tune carefully and systematically. Have SWR curves available. Be prepared to describe your installation in detail.

LIMITED WARRANTY

Butternut Manufacturing Co. warrants on the terms hereof, to a Customer who has purchased a Product from a Seller, for a period of one year from the date of the purchase, that the Product was not Defective, but this warranty is void if the Product has been subjected to improper or abnormal installation or usage, or a serial number on the Product has been defaced or removed.

If a Customer believes that a Product is Defective, the customer may, within such one-year period, return the entire product to Butternut at Butternut's factory, all shipping charges pre-paid by the Customer. If the Product was Defective, Butternut will at its option and expense repair or replace the Product and will at its expense return the repaired or replaced Product to the customer, in a manner selected by Butternut, at the address from which the Customer sent the Product to Butternut.

THE ABOVE WARRANTY AND REMEDY ARE EXCLUSIVE AND ARE IN LIEU OF ALL OTHER WARRANTIES, EXPRESS OR IMPLIED, INCLUDING BUT NOT LIMITED TO IMPLIED WARRANTIES OF MERCHANTABILITY AND FITNESS FOR A PARTICULAR PURPOSE.

NO SELLER WILL BE LIABLE FOR ANY LOSS, INCONVENIENCE OR DAMAGE, INCLUDING DIRECT, SPECIAL, INCIDENTAL OR CONSEQUENTIAL DAMAGES RESULTING FROM THE USE OF OR INABILITY TO USE A PRODUCT, WHETHER THE LIABILITY WOULD RESULT FROM BREACH OF WARRANTY OR UNDER ANY OTHER LEGAL THEORY.

For instance, this warranty does not cover damage to or caused by an antenna (a) by reason of the antenna acting as a lighting rod, (b) by reason of corrosion or strain from exposure of an antenna to wind or weather, (c) from improper assembly, installation or use of an antenna, or (d) from failure periodically to inspect and maintain an antenna and its installation. The Customer is responsible to insure that installation and use of an antenna complies with applicable laws (such as zoning laws) and regulations (such as condominium regulations).

SOME LAWS DO NOT ALLOW THE EXCLUSION OF IMPLIED WARRANTIES, AND IF THESE LAWS APPLY, THEN ALL EXPRESS AND IMPLIED WARRANTIES ARE LIMITED IN DURATION TO SUCH ONE-YEAR PERIOD. NO WARRANTIES OF ANY KIND APPLY AFTER THAT PERIOD.

Such repair or replacement is the Customer's sole and exclusive remedy for a Defective Product. Specifically, Butternut is not liable (to the Customer or otherwise) for (a) any loss or damage arising in any way from a Product or from actual or anticipated sale, lease, license or use of a Product, or involving any matter such as interruption of service, loss of business or anticipated profits, or delay in receiving, repairing, replacing or returning a Product, or (b) any incidental, indirect, special or consequential damages.

No other person (such as an employee, agent or dealer) is authorized to change this warranty in any way, or to give any other warranties of any kind on behalf of Butternut. This warranty gives a Customer specific legal rights, and a Customer may also have other rights, which vary from state to state.

As used herein the *Customer* is the initial end-use purchaser of a Product from a Seller, a *Product* is an antenna or accessory therefor manufactured by Butternut, a Product is *Defective* if and only if the Product was not free of defects of material and workmanship when manufactured, and a *Seller* is Butternut and any authorized Butternut dealer.